

Херуц / POWER
TOOLS
ACCESSORIES

75 YEARS
1947-2022



hepuc.com

> 2022

INDICE / SOMMAIRE / INDEX



- › Brocas para pared
 - › Foret Béton
 - › Masonry Drill bits
- Pag. 10-28**



- › Coronas para pared
 - › Scies tépans Béton
 - › Core Bits
- Pag. 29-31**

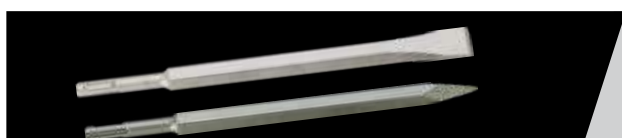

- › Punteros y Cinceles
 - › Pointerolles et Burins
 - › Pointers and Chisels
- Pag. 32-33**



- › Brocas para madera
 - › Forets à bois
 - › Wood drill-bits
- Pag. 34-47**



- › Brocas para metal
 - › Forets à métaux
 - › Metal Drill bits
- Pag. 48-53**



- › Brocas Escalonadas
 - › Fraises étagées
 - › Step Drill-Bits
- Pag. 54-55**



- › Coronas para metal
 - › Scies trépan métaux
 - › Metal Hole Saws
- Pag. 56-67**

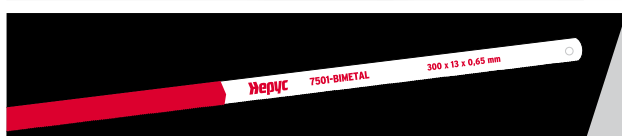

- › Sierras de Mano
 - › Lames de Scies à main
 - › Hand hacksaw blade
- Pag. 68-69**



- › Sierras de Calar
 - › Scies sauteuses
 - › Jig saws
- Pag. 70-71**



- › Sierras de sable
 - › Scies sabre
 - › Sabre saws
- Pag. 72-73**



























































- › Oscilantes Multi-función /
 - › Outils Multifontions
 - › Oscillating Multi-tools
- Pag. 74-77**

















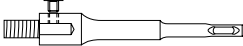



- › Portabrocas
 - › Mandrins
 - › Drill Chucks
- Pag. 78-80**

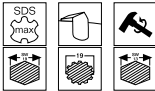

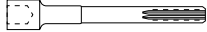
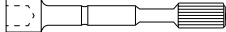

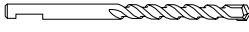

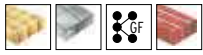
- › Expositores
 - › Présentoirs
 - › Displays
- Pag. 81-85**

Brocas para pared / Forets béton / Masonry drill-bits					
1201	Fasterplus (SDS+)		  		10
1223	Quatroqplus (SDS+)		  		13
1226	Compaqplus (SDS+)		  		16
1222	Performax (SDS max)		  		17
1203	Fastermax (SDS max)		  		18
1207	Optima		 		20
1225	Perfecta		  		21
1208	Diamond		  		22
1502	Diamond Hex.		  		24
1209	Marmolit				25
1227	Porceline		 		27
1228	Porceline Widia				28
1212	Vidrio				28



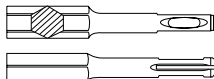

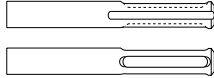

















Coronas pared / Scies-trépan béton / Core bits					
7121	SDS+		 	  	29
7122	MANGO HEXAGONAL				29
7123	MANGO SDS+				29
7124	BROCA DE CENTRAR				29
7153	MANGO BROCA				29

7125	SDS MAX				30
7126	MANGO SDS MAX				30
7127	MANGO ESTRIADO				30
7128	MANGO SW19				30
7129	MANGO SW13				30
7130	BROCA DE CENTRAR				30
7154	TUNGSTENO				31
7160	BROCA DE CENTRAR				31
7161	HUSILLO HEXAGONAL				31

































Punteros y Cinceles / Pointeroles et Burins / Pointers and Chisels

1401	SDS+				32
1405	SDS MAX				33

Brocas para madera / Forets à bois / Wood drill-bits

1301	3P ST		 CV	Maderas blandas Bois tendre Softwoods 	34
1503	3P ST HEX.		 QUICK CHANGE  CV	Maderas blandas Bois tendre Softwoods 	36
1302	3 P PRO		 HSS 	Maderas duras Bois dur Hardwoods 	37
1303	PALA STANDARD		 	Maderas blandas Bois tendre Softwoods 	38
1304	PALA PRO		 	Maderas duras Bois dur Hardwoods 	39
1305	PALA EXTENSIBLE			Maderas duras Bois dur Hardwoods 	40





























Pág.

1320	ALARGADOR				40
1306	LEWIS		 	Maderas duras Bois dur Hardwoods 	41
1321	LEWIS (SDS+)		  	Maderas duras Bois dur Hardwoods 	42
1307	ENCOFRAR			Encofrados Coffrages Shuttering 	43
1318	ENCOFRAR (SDS+)		 	Encofrados Coffrages Shuttering 	44
1308	AVELLANADOR		 	Maderas duras Bois dur Hardwoods 	45
NEW 1314	BROCA FORSTNER			Maderas duras Bois dur Hardwoods 	45
1309	CAZOLETA T1			Maderas duras Bois dur Hardwoods 	46
1310	CAZOLETA T2			Maderas duras Bois dur Hardwoods 	46
1311	CAZOLETA T3			Maderas duras Bois dur Hardwoods 	46

Coronas madera / Scies-trépan bois / Wood core bits

7149	MULTIUSOS		  	       	47
------	-----------	-------------------------------------------------------------------------------------	------------------------------------------------------------------------------------------------------------------------------------------------------------------------------------------------------------------------------------------------------------------	--------------------------------------------------------------------------------------------------------------------------------------------------------------------------------------------------------------------------------------------------------------------------------------------------------------------------------------------------------------------------------------------------------------------------------------------------------------------------------------------------------------------------------------------------------------------------------------------------------------------------------------------------------------------------------------------------------------------	----

Brocas para metal / Forets a metaux / Metal drill-bits

8163	RECTIFICADA (HSS DIN 338N)		   	Acero <80Kg Acier <80Kg Steel <80Kg 	48
1501	HSS HEX.		   	Acero <80Kg Acier <80Kg Steel <80Kg 	50
1154	SPEEDPLUS (HSS DIN 338NSP)		  	Acero <80Kg Acier <80Kg Steel <80Kg 	51
8164	COBALT (HSSCO DIN 338N)		  	Acero <120Kg Acier <120Kg Steel <120Kg 	52
8169	COBALT W (HSS DIN 338W)		   	Acero inox Acier inox Stainless steel 	53



















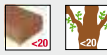



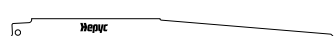



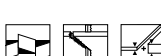

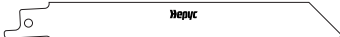

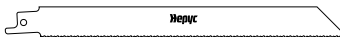



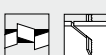







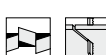









Brocas escalonadas / Fraises étagées / Step drill-bits













5105	BROCA ESCALONADA (HSS)			Acero <80Kg Acier <80Kg Steel <80Kg 	54
5101	BROCA AVELLANADORA			Acero <80Kg Acier <80Kg Steel <80Kg 	55

Coronas metal / Scies-trépan métaux / Metal hole saws					
7111	BIMETAL M42			Acero <80Kg Acier <80Kg Steel <80Kg 	56
7110	BIMETAL DENTADO FINO M42			Acero <80Kg Acier <80Kg Steel <80Kg 	58
7142	BIMETAL DE CAMBIO RÁPIDO M42			Acero <80Kg Acier <80Kg Steel <80Kg 	59
7157	BIMETAL TCT			Acero inox Acier inox Stainless steel 	60
7112	HUSILLO HEXAGONAL				61
7112	HUSILLO EJE SDS+				61
7113	BROCA DE CENTRAR EJE L=85				61
7114	EXTENSIÓN EJE L=330				61
7140	HUSILLO CAMBIO RÁPIDO				61
7144	ADAPTADOR				61
7145	BROCA CENTRAR EJE L				61
7145	KIT CAMBIO RÁPIDO HUSILLO+ADAPTADOR				61
7101	TCT			Acero inox Acier inox Stainless steel 	62
7102	BROCA CENTRAR				63
7103	CONO MORSE				63
7104	HSS REAFILABLES			Acero inox Acier inox Stainless steel 	64
7105	HUSILLO				65
7106	CONO MORSE				65
7113	BROCA DE CENTRAR				65
	ESTUCHES / COFFRETS / CASES				66

Hojas de sierra de mano / Lame de scie à main / Hand hacksaw blade					
7501	BIMETAL			Acero <80Kg Acier <80Kg Steel <80Kg	68
7504	CV			Acero <80Kg Acier <80Kg Steel <80Kg	68
7505	CV			Acero <80Kg Acier <80Kg Steel <80Kg	69
Sierras de calar para madera / Scies sauteuses pour le bois / Jig saws for wood					
7604	HCS CARBONO			<40	70
7603	HCS CARBONO			<50	70
7624	HCS CARBONO			<50	70
7614	HCS CARBONO			<50	70
7601	HCS CARBONO			<25	70
7602	HCS CARBONO			<40	70
7621	HCS CARBONO			<30	70
7622	HCS CARBONO			<50	70
7642	HCS CARBONO			<50	70
7643	HCS CARBONO			<60	70
7644	HCS CARBONO		DVO	<50	70
7623	BIMETAL				70
7645	HM				70
7646	BIMETAL				70

Sierras de calar para metal / Scies sauteuses pour métal / Jig saws for metal					
7626	HSS				70
7607	HSS				70
7609	HSS				70
7611	HSS				70
7647	HSS				70
7648	BIMETAL				70
7629	BIMETAL				70
7649	BIMETAL				70
7650	HM				70
7651	HM				70

Sierras de sable para madera / Scies sabre pour bois / Sabre saws for wood					
7701	HCS CARBONO				72
7702	HCS CARBONO				72
7703	HCS CARBONO				72
7704	BIMETAL				72
7705	BIMETAL				72
7706	BIMETAL				72
Sierras de sable para metal / Scies sabre pour métal / Sabre saws for metal					
7707	BIMETAL				72
7708	BIMETAL				72
7709	BIMETAL				72
7710	BIMETAL				72
7711	BIMETAL				72
7712	BIMETAL				72
7713	BIMETAL				72
Sierras de sable construcción / Scies sabre construction / Sabre saws for construction					
7714	BIMETAL				72
7715	BIMETAL				72
7719	BIMETAL				72
7717	HM				72
7718	HM				72

Oscilantes Multi-función /Outils Multifonctions /Oscillating Multi-tools					
7720 - 7725	MADERA / BOIS / WOOD				74
7726 - 7734	METAL				74
7735	METAL/INOX				74
7736 - 7747	ABRASIVO/ ESPECIAL ABRASIF/ SPÉCIAL ABRASIVE/SPECIAL				76
Portabrocas y accesorios / Mandrins et accessoires / Drill chucks and accessories					
6118	AUTOMATICO				78
6105	LLAVE PRO				78
6106	CON LLAVE				79
6117	SDS+				79
1224	ADAPTADOR SDS +				79
6107	ADAPTADOR BLACK&DECKER				80
6108	ADAPTADOR SDS+				80
6109	LLAVE RECAMBIO				80
EXPOSITORES / PRÉSENTOIRS / DISPLAY STANDS					81
					

**BROCAS PARA PARED
FORETS BÉTON / MASONRY DRILL-BITS**



**APLICACIONES
APPLICATIONS**



Hormigón / Béton / Concrete



**Granito
Granit
Granite**



**Ladrillo
hormigón
Brique béton
Concrete brick**



**Ladrillo
Brique
Brick**

**Características
Caractéristiques
Features**



**Mango
SDS+
Queve SDS+
SDS+ shank**



**Punta
2 cortes
Pointe 2 dents
2-cut tip**



**Percusión
y rotación
Percussion
et rotation
Percussion
and rotation**



PGM

1201 Fasterplus (SDS+)



Ø mm	L mm	l mm	clip		pack	
			Ref. 1201	Ref. 1201/1	€	€
4,00	110	50	5,53	1		
5,00	110	50	4,30	1	3,78	20
5,50	110	50	4,78	1		
6,00	110	50	4,32	1	3,86	20
7,00	110	50	5,94	1		
8,00	110	50	5,48	1	4,94	20
10,00	110	50	6,56	1		
5,00	160	100	5,11	1	4,55	20
5,50	160	100	5,28	1		
6,00	160	100	4,73	1	4,17	20
6,50	160	100	6,11	1		
7,00	160	100	6,31	1		
8,00	160	100	5,62	1	5,14	20
9,00	160	100	7,59	1		
10,00	160	100	6,72	1	6,11	20
11,00	160	100	9,17	1		
12,00	160	100	7,55	1	7,16	20
13,00	160	100	11,22	1		
14,00	160	100	11,22	1		
15,00	160	100	13,86	1		
5,00	210	150	8,70	1		
6,00	210	150	7,96	1		
6,50	210	150	9,67	1		
8,00	210	150	6,82	1		
9,00	210	150	9,06	1		
10,00	210	150	7,83	1	7,28	20
12,00	210	150	8,92	1	8,41	20
13,00	210	150	12,99	1		
14,00	210	150	12,80	1		
16,00	210	150	16,33	1		
17,00	210	150	27,72	1		
18,00	210	150	26,53	1		
20,00	210	150	30,14	1		
24,00*	210	150	56,35	1		
6,00	260	200	8,92	1		
6,50	260	200	15,00	1		
8,00	260	200	8,62	1		
10,00	260	200	9,93	1		
11,00	260	200	11,34	1		
12,00	260	200	11,49	1		
14,00	260	200	14,33	1		
15,00	260	200	18,41	1		
16,00	260	200	18,34	1		

(Hasta fin de existencias / Jusqu'à épuisement des stocks / While supplies last) (continúa Ref.1201 / suite Réf.1201 / Ref.1201 cont'd)

BROCAS PARA PARED
FORETS BÉTON / MASONRY DRILL-BITS

1201 **Fasterplus (SDS+)**



Ø mm	L mm	l mm	clip		pack	
			Ref. 1201	Ref. 1201/1	Ref. 1201	Ref. 1201/1
			€	€	€	€
22,00	260	200	39,89	1		
24,00	260	200	46,88	1		
25,00	260	200	50,14	1		
6,00	310	250	13,78	1		
8,00	310	250	12,52	1		
10,00	310	250	11,34	1		
12,00	310	250	13,84	1		
14,00	310	250	15,43	1		
16,00	310	250	18,95	1		
18,00	310	250	34,38	1		
20,00	310	250	38,21	1		
22,00*	310	250	50,90	1		
24,00*	310	250	74,18	1		
8,00	450	400	19,17	1		
10,00	450	400	16,75	1		
12,00	450	400	19,96	1		
14,00	450	400	24,02	1		
15,00	450	400	31,01	1		
16,00	450	400	32,71	1		
18,00	450	400	35,92	1		
20,00	450	400	41,18	1		
22,00	450	400	54,86	1		
24,00	450	400	56,11	1		
25,00	450	400	65,59	1		
26,00	450	400	61,24	1		
8,00	610	600	33,50	1		
10,00	610	600	30,16	1		
12,00	610	600	34,14	1		
14,00	610	600	36,57	1		
16,00	610	600	36,46	1		
18,00	610	600	54,94	1		

(Hasta fin de existencias / Jusqu'à épuisement des stocks / While supplies last)

APLICACIONES
APPLICATIONS



Hormigón / Béton / Concrete



Granito
Granit
Granite



Ladrillo hormigón
Brique béton
Concrete brick



Ladrillo
Brique
Brick

Características
Caractéristiques
Features



Mango SDS+
Queue SDS+
SDS+ shank



Punta 2 cortes
Pointe 2 dents
2-cut tip



Percusión y rotación
Percussion et rotation
Percussion and rotation



PGM

**BROCAS PARA PARED
FORETS BÉTON / MASONRY DRILL-BITS**



**APLICACIONES
APPLICATIONS**



Hormigón / Béton / Concrete



**Granito
Granit
Granite**



**Ladrillo
hormigón
Brique béton
Concrete brick**



**Ladrillo
Brique
Brick**

**Características
Caractéristiques
Features**



**Mango
SDS+
Queue SDS+
SDS+ shank**



**Punta
2 cortes
Pointe 2 dents
2-cut tip**



**Percusión
y rotación
Percussion
et rotation
Percussion
and rotation**



PGM

1201 > Fasterplus (SDS+)



	Ø mm	L mm	l mm	clip		pack	
				Ref. 1201	Ref. 1201/1	€	€
				€	€		
	20,00	610	600	56,06	1		
	22,00	610	600	88,11	1		
	25,00	610	600	89,78	1		
	10,00	1000	940	70,82	1		
	12,00	1000	940	77,66	1		
	14,00	1000	940	89,02	1		
	16,00	1000	940	88,91	1		
	18,00	1000	940	110,93	1		
	20,00	1000	940	124,88	1		
	22,00	1000	940	127,32	1		
	25,00	1000	940	151,91	1		

> Ref. 1217



Ø mm	L mm	
5,00	110	1
6,00	110	1
8,00	110	1
6,00	160	1
8,00	160	1
10,00	160	1
12,00	160	1
TOTAL		7
€		54,72

1223 Quattroplus (SDS+)



Ref. 1223

Ref. 1223/1

Ø mm	L mm	l mm	clip		pack	
			€	📦	€	📦
4	115	50	6,18	1		
5	110	50	6,18	1	5,57	5
5,5	110	50	6,73	1		
6	115	50	6,58	1	5,93	5
6,5	115	50	6,73	1		
7	110	50	6,67	1		
8	115	50	8,64	1	7,77	5
10	115	50	9,81	1	8,83	5
4	165	100	7,50	1		
5	160	100	7,50	1	6,75	5
5,5	160	100	6,29	1		
6	165	100	7,21	1	6,49	5
6,5	165	100	7,50	1		
7	165	100	7,53	1		
8	165	100	8,64	1	7,77	5
9	165	100	9,75	1		
10	165	100	10,48	1	9,43	5
11	165	100	11,13	1		
12	165	100	13,01	1	11,71	5
14	165	100	15,80	1		
15	165	100	20,14	1		
5	210	150	11,49	1		
5,5	210	150	11,71	1		
6	215	150	9,71	1	8,73	5
6,5	215	150	12,39	1		
7	215	150	12,19	1		
8	210	150	10,83	1	9,74	5
9	215	150	10,99	1		
10	215	150	12,52	1	11,27	5
11	215	150	13,25	1		
12	215	150	15,53	1	13,98	5
14	215	150	20,20	1		
16	215	150	32,37	1		
18	200	150	33,95	1		
20	200	150	36,08	1		
5	265	200	11,13	1		
6	265	200	11,64	1		
8	265	200	11,87	1		
10	265	200	16,11	1		
12	260	200	18,83	1		

APLICACIONES
APPLICATIONS



Hormigón armado
Béton armé
Reinforced concrete



Granito
Granit
Granite



Ladrillo hormigón
Brique béton
Concrete brick



Ladrillo
Brique
Brick

Características
Caractéristiques
Features



Mango SDS+
Queue SDS+
SDS+ shank



Percusión y rotación
Percussion et rotation
Percussion and rotation



PGM

**BROCAS PARA PARED
FORETS BÉTON / MASONRY DRILL-BITS**



**APLICACIONES
APPLICATIONS**



**Hormigón armado
Béton armé
Reinforced concrete**



**Granito
Granit
Granite**



**Ladrillo hormigón
Brique béton
Concrete brick**



**Ladrillo
Brique
Brick**

**Características
Caractéristiques
Features**



**Mango SDS+
Queue SDS+
SDS+ shank**



**Percusión y rotación
Percussion et rotation
Percussion and rotation**



PGM

1223 Quatroplus (SDS+)



Ref. 1223

Ref. 1223/1

Ø mm	L mm	l mm	€	clip	pack
				Ref. 1223	Ref. 1223/1
14	265	200	22,58	1	
15	260	200	33,93	1	
16	265	200	37,43	1	
22	250	200	68,31	1	
24	250	200	70,49	1	
25	250	200	72,29	1	
26	250	200	76,37	1	
5	315	250	15,18	1	
6	315	250	15,18	1	
8	310	250	15,16	1	
10	315	250	20,48	1	
12	315	250	24,46	1	
14	315	250	28,95	1	
16	315	250	39,11	1	
18	300	250	40,70	1	
20	300	250	54,21	1	
8	365	300	18,19	1	
10	365	300	24,57	1	
12	365	300	29,35	1	
14	365	300	34,74	1	
16	360	300	46,94	1	
5	465	400	21,25	1	
6	465	400	23,43	1	
8	460	400	25,09	1	
10	465	400	28,10	1	
12	465	400	30,57	1	
14	465	400	36,26	1	
15	465	400	46,75	1	
16	465	400	49,00	1	
18	450	400	58,91	1	
20	450	400	67,52	1	
22	450	400	81,30	1	
24	450	400	86,08	1	
25	450	400	78,77	1	
26	450	400	100,33	1	
8	615	550	50,87	1	
10	615	550	43,78	1	
12	615	550	52,05	1	
14	615	550	51,33	1	
16	615	550	54,09	1	
18	600	550	64,37	1	
20	600	550	79,02	1	
22	600	550	77,21	1	

1223 Quatropius (SDS+)

> Ref. 1217/3



∅ mm	L mm	
5,00	110	1
6,00	115	1
8,00	115	1
6,00	165	1
8,00	165	1
10,00	165	1
12,00	165	1
TOTAL		7
€		77,70

**BROCAS PARA PARED
FORETS BÉTON / MASONRY DRILL-BITS**

1226 Compaqplus (SDS+)



Ref. 1226

Ref. 1226/1

Ø mm	L mm	l mm	€	clip	€	pack
5	115	50	7,42	1	6,68	5
6	115	50	7,42	1	6,68	5
6,5	115	50	9,65	1		
7	110	50	10,12	1		
8	115	50	9,65	1	8,68	5
10	115	50	11,29	1	10,17	5
5	165	100	8,85	1	7,97	5
6	165	100	8,11	1	7,30	5
6,5	165	100	10,55	1		
7	165	100	11,08	1		
8	165	100	9,75	1	8,78	5
10	165	100	11,45	1	10,30	5
12	165	100	13,78	1	12,40	5
14	165	100	20,25	1	18,22	5
6	215	150	13,83	1	12,46	5
7	215	150	12,88	1		
8	215	150	11,61	1	10,45	5
10	215	150	13,67	1	12,31	5
12	215	150	16,11	1	14,50	5
14	215	150	23,00	1	20,70	5
16	215	150	32,50	1		
6	315	250	15,32	1		
8	315	250	21,36	1		
10	315	250	21,50	1		
12	315	250	25,00	1		
14	315	250	28,30	1		
16	315	250	37,80	1		
8	465	400	33,23	1		
10	465	400	34,10	1		
12	465	400	36,41	1		
14	465	400	43,20	1		
16	465	400	58,78	1		
18	450	400	74,62	1		
20	450	400	73,41	1		
22	450	400	115,86	1		
24	450	400	129,53	1		
25	450	400	132,13	1		
28	450	400	147,18	1		
30	450	400	157,30	1		
16	600	550	68,32	1		
18	600	550	96,73	1		
20	600	550	156,77	1		
22	600	550	156,77	1		
25	600	550	193,45	1		
16	1000	950	165,73	1		
18	1000	950	194,99	1		
20	1000	950	223,66	1		
22	1000	950	236,86	1		
25	1000	950	269,24	1		

**APLICACIONES
APPLICATIONS**



**Hormigón armado
Béton armé
Reinforced concrete**



**Granito
Granit
Granite**



**Hormigón
Béton
Concrete**



**Ladrillo
Brique
Brick**

**Características
Caractéristiques
Features**



**Mango
SDS+
Queue SDS+
SDS+ shank**



**Percusión
y rotación
Percussion
et rotation
Percussion
and rotation**



PGM

1226 Compaqplus (SDS+)

> Ref. 1217/2



Ø mm	L mm	
5,00	115	1
6,00	115	1
8,00	115	1
6,00	165	1
8,00	165	1
10,00	165	1
12,00	165	1
TOTAL		7
€		86,01

1222 Performax (SDS MAX)

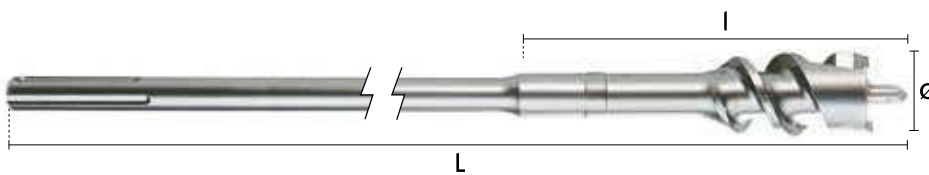

Ref. 1222

Ø mm	L mm	l mm	€	
45,00	590	450	419,34	1
55,00	590	450	491,27	1
65,00	590	450	558,97	1
80,00	590	450	693,83	1
45,00	990	850	459,70	1
55,00	990	850	495,07	1
65,00	990	850	610,62	1
80,00	990	850	743,10	1

APLICACIONES
APPLICATIONS



Hormigón armado
Béton armé
Reinforced concrete



Granito
Granit
Granite



Ladrillo hormigón
Brique béton
Concrete brick



Ladrillo
Brique
Brick

Características
Caractéristiques
Features



Mango SDS MAX
Queue SDS MAX
SDS Max shank



Punta perforadora
Pointe perforatrice
Drilling tip



Percusión y rotación
Percussion et rotation
Percussion and rotation

**BROCAS PARA PARED
FORETS BÉTON / MASONRY DRILL-BITS**

1203 > Fastermax (SDS MAX)

**APLICACIONES
APPLICATIONS**



**Hormigón armado
Béton armé
Reinforced concrete**



**Granito
Granit
Granite**



**Ladrillo hormigón
Brique béton
Concrete brick**



**Ladrillo
Brique
Brick**

**Características
Caractéristiques
Features**



**Mango
SDS MAX
Queue
SDS MAX
SDS Max
shank**



**Punta
4 cortes
Pointe
4 dents
4-cut tip**



**Percusión
y rotación
Percussion
et rotation
Percussion
and rotation**



**2 cortes
2 pointe
2 cut tip**



Ref. 1203

Ø mm	L mm	l mm	€	
12,00	340	200	69,93	1
14,00	340	200	83,87	1
15,00	340	200	93,68	1
16,00	340	200	93,68	1
18,00	340	200	96,35	1
20,00	340	200	96,35	1
22,00	340	200	99,04	1
24,00	340	200	101,22	1
25,00	340	200	104,65	1
26,00	340	200	111,50	1
28,00	340	200	120,68	1
30,00	340	200	132,73	1
32,00	340	200	132,74	1
12,00	540	360	81,20	1
14,00	540	360	96,11	1
15,00	540	360	97,33	1
16,00	540	360	102,46	1
18,00	540	360	105,13	1
20,00	540	360	110,79	1
22,00	540	360	115,67	1
24,00	540	360	135,49	1
25,00	540	360	129,11	1
26,00	540	360	137,93	1
28,00	540	360	137,93	1
30,00	540	360	153,56	1
32,00	540	360	165,33	1
35,00	540	360	186,81	1
38,00	540	360	247,47	1
40,00	540	360	314,96	1
45,00	540	360	410,38	1
16,00	690	550	132,04	1
18,00	690	550	132,04	1
20,00	690	550	152,10	1
22,00	690	550	152,10	1
25,00	690	550	168,82	1
28,00	690	550	179,73	1
32,00	690	550	203,11	1
35,00	690	550	203,00	1
38,00	690	550	313,74	1

BROCAS PARA PARED
FORETS BÉTON / MASONRY DRILL-BITS

1203 **Fastermax (SDS MAX)**



Ref. 1203

Ø mm	L mm	l mm	€	
40,00	690	550	352,96	1
16,00	920	780	148,77	1
18,00	920	780	150,41	1
20,00	920	780	164,65	1
22,00	920	780	164,65	1
25,00	920	780	188,04	1
28,00	920	780	250,74	1
32,00	920	780	250,74	1
35,00	920	780	321,82	1
36,00*	920	780	327,68	1
40,00	920	780	380,15	1
20,00	1320	1170	266,70	1
25,00	1320	1170	360,48	1
28,00	1320	1170	425,63	1
32,00	1320	1170	489,44	1
36,00*	1320	1170	641,87	1
40,00	1320	1170	941,21	1

(Hasta fin de existencias / Jusqu'à épuisement des stocks / While supplies last)

APLICACIONES
APPLICATIONS



Hormigón armado
Béton armé
Reinforced concrete



Granito
Granit
Granite



Ladrillo hormigón
Brique béton
Concrete brick



Ladrillo
Brique
Brick

Características
Caractéristiques
Features



Mango SDS MAX
Queue SDS MAX
SDS Max shank



Punta 4 cortes
Pointe 4 dents
4-cut tip



Percusión y rotación
Percussion et rotation
Percussion and rotation

**BROCAS PARA PARED
FORETS BÉTON / MASONRY DRILL-BITS**



**APLICACIONES
APPLICATIONS**



Gres / Grès / Stoneware



Hormigón
Béton
Concrete



Ladrillo
Brique
Brick



Acero <80Kg
Acier <80Kg
Steel <80Kg



Maderas blandas
Bois tendre
Softwoods



Plástico
Plastique
Plastic

**Características
Caractéristiques
Features**



Punta
2 cortes
Pointe 2 dents
2-cut tip



Fresado
tipo S
Fraisage type S
S-type milling



Percusión
y rotación
Percussion
et rotation
Percussion
and rotation

1207 Óptima

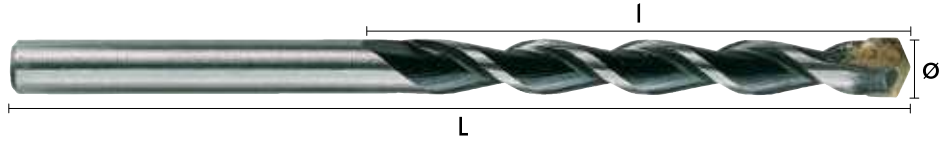

Ø mm	L mm	l mm	tubo		pack	
			Ref. 1207	Ref. 1207/1	Ref. 1207	Ref. 1207/1
3,00	70	40	5,09	1	4,63	10
4,00	75	40	4,91	1	4,46	10
5,00	85	50	5,50	1	5,00	10
6,00	100	60	5,58	1	5,05	10
7,00	100	60	5,90	1		
8,00	120	80	6,37	1	5,77	10
9,00	120	80	7,35	1		
10,00	120	80	8,48	1	7,71	5
11,00	150	90	10,56	1		
12,00	150	90	12,01	1	10,91	5
14,00	150	90	16,03	1		
5,00	150	90	9,85	1		
6,00	150	90	10,39	1		
8,00	200	150	11,02	1		
10,00	200	150	13,00	1		
12,00	200	150	13,58	1		

Estuches / Coffrets / Cases

> Ref. 8128/4



Ø mm	€	pack
3,00 - 4,00 - 5,00 - 6,00 - 7,00 - 8,00 - 9,00 - 10,00	53,80	8

> Ref. 8130/4



Ø mm	€	pack
4,00 - 5,00 - 6,00 - 8,00 - 10,00	34,52	5

BROCAS PARA PARED FORETS BÉTON / MASONRY DRILL-BITS

1225 Perfecta

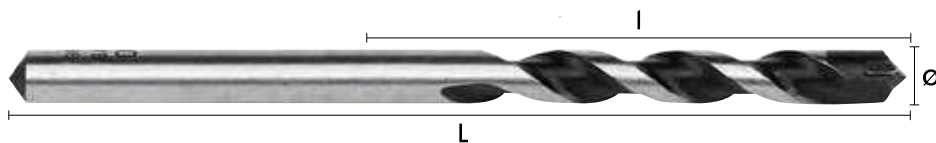

Ø mm	L mm	l mm	tubo		pack	
			Ref. 1225	Ref. 1225/1	Ref. 1225	Ref. 1225/1
3,00	70	35	3,05	1	2,79	10
3,50*	70	35	3,13	1		
4,00	75	40	3,05	1	2,79	10
5,00	85	50	3,13	1	2,85	10
6,00	100	60	3,60	1	3,29	10
7,00	100	60	4,09	1		
8,00	120	70	4,47	1	4,09	10
9,00	120	70	5,14	1		
10,00	120	80	6,02	1	5,46	5
11,00*	150	80	8,08	1		
12,00	150	80	8,32	1	7,56	5
13,00*	150	80	10,59	1		
14,00	150	80	13,04	1		
15,00*	160	80	15,13	1		
16,00	160	80	16,83	1		
18,00*	160	80	22,32	1		
20,00	160	80	26,68	1		
6,00	150	80	4,74	1		
8,00*	150	80	5,34	1		
8,00	250	170	7,54	1		
10,00	250	170	9,51	1		
12,00*	250	170	12,84	1		
14,00*	250	170	23,36	1		

(Hasta fin de existencias / Jusqu'à épuisement des stocks / While supplies last)

Estuches / Coffrets / Cases

> Ref. 8130/5

Ø mm	€	pack
400 500 600 800 1000	24,33	5



APLICACIONES APPLICATIONS



Granito / Granit / Granite



Hormigón
Béton
Concrete



Ladrillo
hormigón
Brique béton
Concrete brick



Ladrillo
Brique
Brick



Cerámica
Céramique
Ceramic



Gres
Grès
Stoneware



Mármol
Marbre
Marble

Características Caractéristiques Features



Punta
2 cortes
Pointe 2 dents
2-cut tip



Fresado
tipo U
Fraisage type U
U-type milling



Percusión
y rotación
Percussion
et rotation
Percussion
and rotation



Punta soldada
a 1100°
Pointe soudée à 1100°
Tip soldered at 1100°

**BROCAS PARA PARED
FORETS BÉTON / MASONRY DRILL-BITS**

1208 Diamond

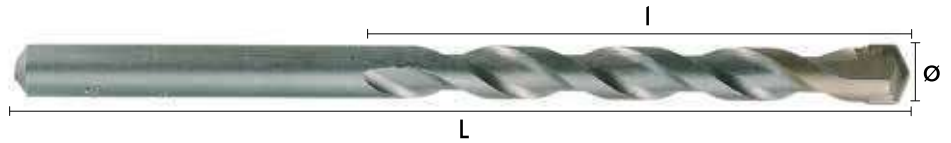

**APLICACIONES
APPLICATIONS**



**Hormigón
Béton
Concrete**



**Ladrillo
hormigón
Brique béton
Concrete brick**



**Ladrillo
Brique
Brick**



**Gres
Grès
Stoneware**



**Cerámica
Céramique
Ceramic**



**Mármol
Marbre
Marble**

**Características
Caractéristiques
Features**



**Punta
2 cortes
Pointe 2 dents
2-cut tip**



**Fresado
tipo U
Fraisage type U
U-type milling**



**Percusión
y rotación
Percussion
et rotation
Percussion
and rotation**



**Punta soldada
a 1100°
Pointe soudée à 1100°
Tip soldered at 1100°**



tubo



pack

Ref. 1208

Ref. 1208/1

Ø mm	L mm	l mm	Ref. 1208		Ref. 1208/1	
			€	pack	€	pack
3,00	70	40	2,42	1	2,19	10
3,50	70	40	2,29	1		
4,00	75	40	2,37	1	2,16	10
4,50	80	50	2,29	1		
5,00	85	50	2,37	1	2,16	10
5,50	85	50	2,42	1		
6,00	100	60	2,65	1	2,41	10
6,50	100	60	3,04	1		
7,00	100	60	2,95	1		
8,00	120	80	3,18	1	2,88	10
9,00	120	80	3,64	1		
10,00	120	80	4,58	1	4,16	5
11,00	150	90	5,95	1		
12,00	150	90	6,65	1	6,04	5
13,00	150	90	8,16	1		
14,00	150	90	10,06	1		
15,00	160	100	11,62	1		
16,00	160	100	12,94	1		
18,00	160	100	17,18	1		
20,00	160	100	20,53	1		
22,00	160	100	23,59	1		
25,00	160	100	27,10	1		
5,00	150	90	3,29	1		
5,50	150	90	3,68	1		
6,00	150	90	3,64	1		
6,50	150	90	5,30	1		
7,00	150	90	4,21	1		
8,00	150	90	4,97	1		
10,00	150	90	6,46	1		
8,00	200	150	5,91	1		
10,00	200	150	7,46	1		
12,00	200	150	7,53	1		
10,00	300	250	7,37	1		
12,00	300	250	9,87	1		
14,00	300	250	17,98	1		
8,00	400	350	12,77	1		
10,00	400	350	13,36	1		
12,00	400	350	15,84	1		
14,00	400	350	20,30	1		
16,00	400	350	23,87	1		
18,00 *	400	350	26,24	1		
20,00 *	400	350	31,03	1		
22,00 *	400	350	36,71	1		
24,00 *	400	350	43,30	1		
10,00	600	550	18,44	1		
12,00	600	550	18,73	1		
14,00 *	600	550	22,34	1		
16,00 *	600	550	26,80	1		
18,00 *	600	550	31,44	1		
20,00 *	600	550	40,00	1		

(Hasta fin de existencias / Jusqu'à épuisement des stocks / While supplies last)

1208 Diamond

Estuches / Coffrets / Cases

> Ref. 8128/3



Ø mm	€	
3,00 - 4,00 - 5,00 - 6,00 - 7,00 - 8,00 - 9,00 - 10,00	28,78	8

> Ref. 8130/3



Ø mm	€	
4,00 - 5,00 - 6,00 - 8,00 - 10,00	18,73	5

APLICACIONES
APPLICATIONS



Hormigón
Béton
Concrete



Ladrillo hormigón
Brique béton
Concrete brick



Ladrillo
Brique
Brick



Gres
Grès
Stoneware



Cerámica
Céramique
Ceramic



Mármol
Marbre
Marble

Características
Caractéristiques
Features



Punta 2 cortes
Pointe 2 dents
2-cut tip



Fresado tipo U
Fraisage type U
U-type milling



Percusión y rotación
Percussion et rotation
Percussion and rotation



Punta soldada a 1100°
Pointe soudée à 1100°
Tip soldered at 1100°

BROCAS ENGANCHE HEXAGONAL 1/4"
FORETS EMMANCHEMENT HEXAGONAL 1/4"
DRILL-BITS WITH HEXAGON SHANK 1/4"

1502 **DIAMOND Hex.**

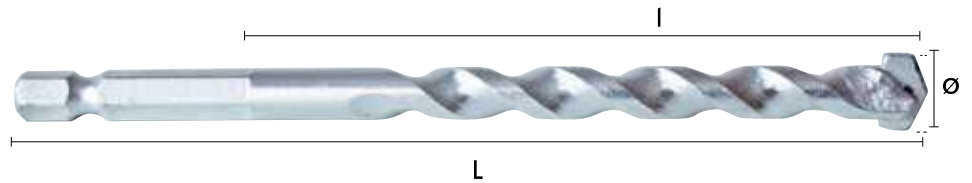

APLICACIONES
APPLICATIONS



Hormigón
Béton
Concrete



Ladrillo hormigón
Brique béton
Concrete brick



Ladrillo
Brique
Brick



Gres
Grès
Stoneware



Cerámica
Céramique
Ceramic



Mármol
Marbre
Marble

Características
Caractéristiques
Features



Punta 2 cortes
Pointe 2 dents
2-cut tip



Fresado tipo U
Fraisage type U
U-type milling



Percusión y rotación
Percussion et rotation
Percussion and rotation



Punta soldada a 1100°
Pointe soudée à 1100°
Tip soldered at 1100°



Mango hexagonal 1/4"
Queue hexagonale 1/4"
Hexagonal shank 1/4"



Cambio rápido
Change rapide
Quick change



Ref. 1502

Ø mm	L mm	l mm	€	
3,00	60	35	2,53	1
4,00	75	35	2,71	1
5,00	85	35	3,39	1
6,00	100	50	3,72	1
7,00	100	50	4,06	1
8,00	120	70	4,40	1
9,00	120	70	5,09	1
10,00	120	70	5,60	1
12,00	150	80	6,76	1

BROCAS PARA PARED FORETS BÉTON / MASONRY DRILL-BITS

1209 Marmolit



Ref. 1209

Ø mm	L mm	l mm	€	
3,00	60	40	1,06	1
3,50	60	40	1,18	1
4,00	75	40	0,92	1
5,00	85	50	0,96	1
5,50*	85	50	1,18	1
6,00	100	60	1,06	1
7,00	100	60	1,27	1
8,00	120	80	1,48	1
9,00	120	80	1,79	1
10,00	120	80	2,20	1
11,00	150	90	2,64	1
12,00	150	90	2,87	1
13,00	150	90	4,25	1
14,00	150	90	4,72	1
15,00	150	100	5,69	1
16,00	150	100	6,22	1
18,00	160	100	7,78	1
20,00	160	100	10,64	1
24,00*	160	100	17,48	1
25,00*	160	100	18,31	1
5,00	150	90	2,49	1
6,00	150	90	2,67	1
7,00*	150	90	2,84	1
6,00	200	150	3,74	1
7,00*	200	150	3,98	1
8,00	200	150	4,42	1
9,00*	200	150	4,73	1
10,00	200	150	4,91	1
11,00*	200	150	4,96	1
12,00	200	150	5,07	1
6,00	300	250	4,97	1
7,00*	300	250	5,41	1
8,00	300	250	5,47	1
9,00*	300	250	5,55	1
10,00	300	250	5,60	1
12,00	300	250	6,47	1
13,00	300	250	7,84	1
14,00	300	250	7,96	1
16,00	300	250	11,26	1
18,00	300	250	12,99	1
20,00	300	250	17,51	1
6,00	400	350	5,78	1
7,00*	400	350	6,14	1
8,00	400	350	6,22	1

(Hasta fin de existencias / Jusqu'à épuisement des stocks / While supplies last)

APLICACIONES APPLICATIONS



Ladrillo / Brique / Brick



Cerámica
Céramique
Ceramic



Ladrillo
hormigón
Brique béton
Concrete brick



Hormigón
Béton
Concrete

Características Caractéristiques Features



Punta
2 cortes
Pointe 2 dents
2-cut tip



Percusión
y rotación
Percussion
et rotation
Percussion
and rotation

**BROCAS PARA PARED
FORETS BÉTON / MASONRY DRILL-BITS**



**APLICACIONES
APPLICATIONS**



Ladrillo / Brique / Brick



**Cerámica
Céramique
Ceramic**



**Ladrillo hormigón
Brique béton
Concrete brick**



**Hormigón
Béton
Concrete**

**Características
Caractéristiques
Features**



**Punta
2 cortes
Pointe 2 dents
2-cut tip**



**Percusión
y rotación
Percussion
et rotation
Percussion
and rotation**

1209 Marmolit



Ref. 1209

Ø mm	L mm	l mm	€	
10,00	400	350	6,84	1
12,00	400	350	7,84	1
14,00	400	350	8,60	1
15,00	400	350	9,83	1
16,00	400	350	12,07	1
18,00	400	350	14,31	1
20,00	400	350	19,73	1
22,00 *	400	350	35,69	1
8,00	600	550	8,49	1
10,00	600	550	9,25	1
12,00	600	550	9,99	1
14,00	600	550	11,48	1
16,00	600	550	15,67	1
18,00	600	550	17,33	1
20,00	600	550	25,32	1
22,00 *	600	550	38,38	1
28,00 *	600	550	95,41	1

(Hasta fin de existencias / Jusqu'à épuisement des stocks / While supplies last)

Estuches / Coffrets / Cases

> Ref. 8128/2



> Ref. 8130/2



Ø mm	€	
3,00 - 4,00 - 5,00 - 6,00 - 7,00 - 8,00 - 9,00 - 10,00	15,41	8

Ø mm	€	
4,00 - 5,00 - 6,00 - 8,00 - 10,00	10,31	5

1227 **Porceline**



Ref. 1227

Ø mm	L mm	€	
5,00	55	21,92	1
6,00	55	24,61	1
7,00	55	26,02	1
8,00	55	27,06	1
10,00	55	29,30	1
12,00	55	31,25	1
15,00	55	33,85	1
20,00	55	39,17	1
25,00	55	47,40	1
35,00	55	49,40	1

> Ref. 1227/1 **Dispensador de agua** / Réservoir d'eau / Water dispenser



Ø mm	€	
5,00 - 10,00	3,56	1
12,00 - 25,00	3,56	1

> Ref. 8138



Ref.	Ø mm	€	
8138	5,00-6,00-7,00-8,00-10,00 + dispensador	134,66	1

APLICACIONES
APPLICATIONS



Porcelanato
Céramique dur / Hard tile



Gres
Grès
Stoneware



Cerámica
Céramique
Ceramic



Granito
Granit
Granite



Vidrio
Verre
Glass

Características
Caractéristiques
Features



Diamante
Diamant
Diamond



Rotación
Rotation
Rotation



1
Refrigerar de manera abundante la zona a perforar.
Refrroidir abondamment la zone à perforeur.
Cool the area to be drilled.



2
Comenzar a perforar en un ángulo de 45° hasta realizar una pequeña muesca.
Commencer à perforeur à un angle de 45° jusqu'à obtenir une petite encoche.
Start to drill at a 45° angle until you make a small notch.



3
Perforar de forma perpendicular hasta realizar el orificio.
Perforeur perpendiculairement jusqu'à réalisation de l'orifice.
Drill at a right angle until you make a hole.

**BROCAS PARA PARED
FORETS BÉTON / MASONRY DRILL-BITS**



**APLICACIONES
APPLICATIONS**



Porcelanato
Céramique dur / Hard tile



Gres
Grès
Stoneware



Cerámica
Céramique
Ceramic

**Características
Caractéristiques
Features**



Rotación
Rotation
Rotation



**APLICACIONES
APPLICATIONS**



Vidrio / Verre / Glass



Cerámica
Céramique
Ceramic



Gres
Grès
Stoneware

**Características
Caractéristiques
Features**



Punta Ojiva
Pointe Ogive
Pointed tip



Rotación
Rotation
Rotation

1228 Porceline Widia



Ref. 1228

Ø mm	L mm	l mm	€	
3,00*	85	40	17,08	1
4,00	85	50	17,08	1
5,00	85	50	18,06	1
6,00	100	65	18,89	1
7,00*	125	75	21,62	1
8,00	126	75	23,43	1
9,00*	150	90	28,40	1
10,00	150	90	28,40	1

(Hasta fin de existencias / Jusqu'à épuisement des stocks / While supplies last)

1212 Vidrio



Ref. 1212

Ø mm	L mm	€	
3,00	58	5,42	1
4,00	64	5,58	1
5,00	70	6,14	1
6,00	76	6,64	1
7,00	77	7,89	1
8,00	83	8,31	1
9,00	84	11,23	1
10,00	90	11,23	1
12,00	97	16,95	1

7121 **SDS+**



clip

Ref. 7121				
Ø mm	z	€	Icon	
25,00	4	65,87	1	
30,00	6	70,62	1	
35,00	6	75,76	1	
40,00	6	82,55	1	
50,00	6	94,67	1	
65,00	6	95,54	1	
68,00	6	107,37	1	
82,00	6	137,15	1	
90,00	6	161,47	1	
100,00	6	183,04	1	
112,00	6	220,72	1	

Accesorios / Accessoires / Accessories

> Ref. 7122 Mango hexagonal / Queue hexagonale / Hexagonal shank

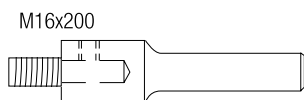

L mm	€	Icon
78	36,50	1
220	51,21	1
370	62,26	1

> Ref. 7123 Mango SDS+ / Queue SDS+ / SDS+ Shank



L mm	€	Icon
105	42,90	1
220	57,44	1
370	68,27	1

> Ref. 7124 Broca de centrar Ø 8 / Foret de centrage Ø 8 / Centre drill-bit Ø 8



L mm	€	Icon
120	9,25	1

> Ref. 7153 Mango broca / Queue foret / Drill-bit shank



L mm	€	Icon
175	79,92	1
340	104,54	1
440	121,94	1

APLICACIONES
APPLICATIONS



Hormigón / Béton / Concrete



Granito
Granit
Granite



Ladrillo hormigón
Brique béton
Concrete brick



Ladrillo
Brique
Brick

Características
Caractéristiques
Features



Mango SDS+
Queue SDS+
SDS+ shank



Punta Dientes MD
Pointe Dents de MD
MD tooth tip



Percusión y rotación
Percussion et rotation
Percussion and rotation



**APLICACIONES
APPLICATIONS**



Hormigón / Béton / Concrete



**Granito
Granit
Granite**



**Ladrillo
hormigón
Brique béton
Concrete brick**



**Ladrillo
Brique
Brick**

**Características
Caractéristiques
Features**



**Mango
SDS MAX**
Queue
SDS MAX
SDS Max
shank



**Mango
estriado**
Queue
canalée
Ribbed
shank



Mango SW 19
Queue SW 19
SW 19 shank



Mango SW 13
Queue SW 13
SW 13 shank



**Punta
Dientes MD**
Pointe
Dents de MD
MD tooth tip



**Percusión
y rotación**
Percussion
et rotation
Percussion
and rotation

7125 SDS MAX

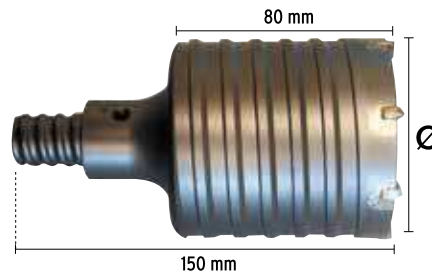

Ref. 7125

Ø mm	Z	€	
45,00	4	155,24	1
50,00	6	185,61	1
55,00	6	202,48	1
68,00	6	215,96	1
82,00	6	307,09	1
90,00	6	357,71	1
100,00	6	388,07	1
125,00	6	438,70	1
150,00	6	573,69	1

Accesorios / Accessoires / Accessories

> Ref. 7126 Mango SDS MAX / Queue SDS MAX / SDS MAX Shank

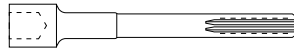

L mm	€	
200	94,67	1
460	111,59	1

> Ref. 7127 Mango estriado / Queue canalée / Ribbed shank

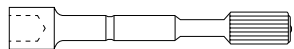

L mm	€	
200*	94,67	1
460*	111,59	1

(Hasta fin de existencias / Jusqu'à épuisement des stocks / While supplies last)

> Ref. 7128 SW 19

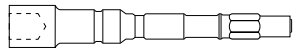

L mm	€	
200*	94,67	1
460*	111,59	1

(Hasta fin de existencias / Jusqu'à épuisement des stocks / While supplies last)

> Ref. 7129 SW 13

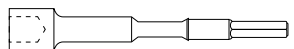

L mm	€	
200*	94,67	1
460*	111,59	1

(Hasta fin de existencias / Jusqu'à épuisement des stocks / While supplies last)

> Ref. 7130 Broca de centrar Ø 11 / Foret de centrage Ø 11 / Centre drill-bit Ø 11



L mm	€	
135	19,80	1

CORONAS PARED SCIÉS-TRÉPAN BÉTON / CORE BITS

7154 Tungsteno

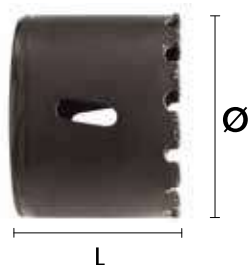

Ref. 7154

Ø mm	L mm	€	Icon
16,00	40	13,44	1
19,00	40	14,08	1
20,00	40	14,73	1
22,00	40	16,04	1
25,00	40	17,63	1
29,00	40	19,07	1
30,00 *	40	19,00	1
32,00	40	19,83	1
35,00	40	19,94	1
38,00	40	21,36	1
44,00	40	21,60	1
48,00	40	22,13	1
51,00	40	22,43	1
54,00	40	24,14	1
57,00	40	24,93	1
60,00	40	25,22	1
64,00	40	25,51	1
70,00	40	27,30	1
76,00	40	28,94	1
83,00	40	29,37	1
86,00	40	31,19	1
95,00	40	39,71	1
102,00	40	35,38	1

(Hasta fin de existencias / Jusqu'à épuisement des stocks / While supplies last)

Accesorios / Accessoires / Accessories

> Ref. 7160 Broca de Centrar / Foret de centrage / Centre drill-bit

Ø mm	€	Icon
8,00	8,35	1

> Ref. 7161 Husillo hexagonal / Arbre hexagonal / Hexagonal spindle

Rosca / Filetage / Thread	Ø mm	€	Icon
1/2 UNF	16,00-30,00	20,34	1
5/8 UNF	31,00-114,00	37,71	1

APLICACIONES APPLICATIONS



Gres / Grès / Stoneware



Porcelanato
Céramique dur
Hard tile



Fibra de vidrio
Fibre de verre
Fibreglass



Ladrillo
Brique
Brick

Características Caractéristiques Features



Taladro manual 20 mm
Perceuse manuel 20 mm
Manual drill 20 mm



APLICACIONES
APPLICATIONS



Hormigón / Béton / Concrete



Granito
Granit
Granite



Ladrillo hormigón
Brique béton
Concrete brick



Ladrillo
Brique
Brick

Características
Caractéristiques
Features



Mango SDS+
Queue SDS+
SDS+ shank



Percusión
Percussion
Percussion

1401 **SDS+**

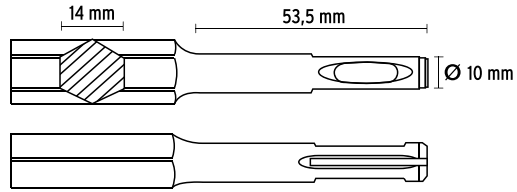

Ref. 1401	clip	Ref. 1401/1	pack	L mm		p gr	TG mm	Diagram	€	€
				€	pack					
001		250	270	20	12,19	1	11,62	5		
002		250	260	-	12,19	1	11,62	5		
005		250	350	22	23,86	1	-	-		
003		250	330	40	20,88	1	-	-		
006		250	520	22	79,96	1	-	-		
011		260	260	40	26,22	1	-	-		
007		250	270	20	14,00	1	-	-		
008		250	270	-	14,00	1	-	-		
009		250		40	24,55	1	-	-		
		250		60	27,23	1	-	-		

Elu, Felisati, Hilti, Kress, Makita, Aeg, Atlas Copco, Black & Decker, Bosch, Dewalt, Metabo.

1405 SDS MAX

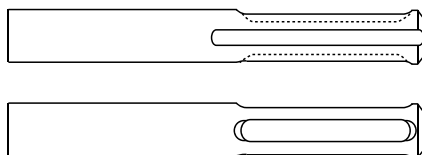

APLICACIONES
APPLICATIONS



Hormigón / Béton / Concrete



Granito
Granit
Granite



Ladrillo hormigón
Brique béton
Concrete brick



Ladrillo
Brique
Brick

Características
Caractéristiques
Features



Mango SDS MAX
Queue SDS MAX
SDS Max shank



Percusión
Percussion
Percussion

	L mm	P gr	TG mm	clip		pack	
				Ref. 1405	Ref. 1405/1		
				€	€	€	€
001	280 400 600	500 730 1130	25 25 25	17,28 17,23 22,99	1 1 1	16,41	5
002	280 400 600	480 710 1110	- - -	17,28 17,23 22,99	1 1 1	16,41	5
003	400	790	50	34,93	1	-	-
004	300	780	80	38,79	1	-	-
005	300	570	26	35,80	1	-	-
006	380	940	35	131,54	1	-	-
007	400	730	25	19,81	1	-	-
008	400	710	-	19,81	1	-	-
009	350	790	50	40,85	1	-	-
010	400	790	-	23,10	1	-	-
011	300	710	50	36,70	1	-	-

Elu, Hilti, Hitachi, Kango, Makita, Aeg, Atlas Copco, Bosch, Dewalt, Metabo, Milwaukee, Spit.

**BROCAS PARA MADERA
FORETS À BOIS / WOOD DRILL-BITS**



**APLICACIONES
APPLICATIONS**



Maderas blandas
Bois tendre / Softwoods



**Aglomerado
Stratifié
Plywood**

**Características
Caractéristiques
Features**



**3 puntas
madera**
3 dents bois
3-tip wood



Cromo vanadio
Chrome vanadium
Chromium Vanadium

1301 3P ST



Ref. 1301

Ø mm	L mm	l mm	€	
3,00	60	30	0,66	1
4,00	70	40	0,72	1
5,00	85	45	0,78	1
6,00	90	50	1,08	1
7,00	105	60	1,23	1
8,00	110	65	1,47	1
9,00	115	70	1,72	1
10,00	120	70	1,87	1
11,00	130	75	2,23	1
12,00	140	85	2,43	1
13,00	150	95	2,46	1
14,00	150	95	2,63	1
15,00	160	100	2,88	1
16,00	160	105	3,47	1
18,00	180	125	4,57	1
20,00	200	130	5,63	1
6,00	300	150	2,80	1
8,00	300	150	3,50	1
10,00	300	150	4,07	1
12,00	300	150	5,05	1
14,00	300	150	6,29	1
16,00	300	150	8,45	1
18,00	300	150	11,09	1
20,00	300	150	12,89	1

Estuches / Coffrets / Cases

> Ref. 8131/2



Ø mm	€	
3,00 - 4,00 - 5,00 - 6,00 - 7,00 - 8,00 - 9,00 - 10,00	13,28	8

> Ref. 8132/2



Ø mm	€	
4,00 - 5,00 - 6,00 - 8,00 - 10,00	8,97	5

BROCAS PARA MADERA FORETS À BOIS / WOOD DRILL-BITS

Estuches / Coffrets / Cases

> Ref. 8133 Estuche Brocas Combinadas (HSS,MARMOLIT,3P)



Ø mm HSS	Ø mm Muros / Murs / Walls Marmolit	Ø mm Madera / Bois / Wood 3 P	€	
4 - 5 - 6 - 8	4 - 5 - 6 - 8	-	14,28	8

> Ref. 8134 Estuche Brocas Combinadas (HSS,MARMOLIT,3P)



Ø mm HSS	Ø mm Muros / Murs / Walls Marmolit	Ø mm Madera / Bois / Wood 3 P	€	
4 - 6 - 8	4 - 6 - 8	4 - 6 - 8	17,12	9

> Ref. 8136 Estuche Brocas Combinadas (HSS, MARMOLIT,3P)



Ø mm HSS	Ø mm Muros / Murs / Walls Marmolit	Ø mm Madera / Bois / Wood 3 P	€	
5 - 6 - 8	5 - 6 - 8	5 - 6 - 8	17,51	9

**BROCAS PARA MADERA
FORETS À BOIS / WOOD DRILL-BITS**



**APLICACIONES
APPLICATIONS**



Aglomerado
Stratifié
Plywood

Maderas blandas
Bois tendre / Softwoods

**Características
Caractéristiques
Features**



**3 puntas
madera**
3 dents bois
3-tip wood



Cromo vanadio
Chrome vanadium
Chromium Vanadium



**Mango
hexagonal 1/4"**
Queue
hexagonale 1/4"
Hexagonal
shank 1/4"



Cambio rápido
Change rapide
Quick change

1503 ST Hex.

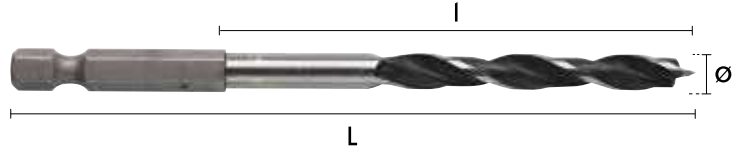

Ref. 1503

Ø mm	L mm	l mm	€	
2,00	70	24	1,02	1
3,00	82	33	0,85	1
4,00	96	43	0,93	1
5,00	106	52	1,19	1
6,00	113	57	1,27	1
7,00	129	69	1,43	1
8,00	117	75	1,70	1
9,00	125	81	1,78	1
10,00	133	87	2,04	1
11,00	142	94	2,20	1
12,00	151	101	2,46	1

1302 **3P Pro**



Ref. 1302

Ø mm	L mm	l mm	€	
3,00	60	30	1,25	1
4,00	75	43	1,33	1
5,00	85	52	1,60	1
6,00	100	63	2,04	1
7,00	100	60	2,30	1
8,00	120	75	2,63	1
9,00	120	81	3,47	1
10,00	120	70	3,98	1
11,00	150	75	4,59	1
12,00	150	85	5,34	1
13,00	150	95	5,62	1
14,00	150	95	8,50	1
15,00	160	100	12,68	1
16,00	160	105	12,01	1
18,00	160	125	21,19	1
20,00	160	130	25,98	1
6,00	300	160	7,26	1
8,00	300	160	9,99	1
10,00	300	160	12,60	1
12,00	300	160	16,15	1
14,00	300	160	20,77	1
16,00	300	160	26,71	1
18,00 *	300	160	33,47	1
20,00 *	300	160	41,88	1

(Hasta fin de existencias / Jusqu'à épuisement des stocks / While supplies last)

Estuches / Coffrets / Cases

> Ref. 8131/1



Ø mm	€	
3,00 - 4,00 - 5,00 - 6,00 - 7,00 - 8,00 - 9,00 - 10,00	22,38	8

> Ref. 8132/1



Ø mm	€	
4,00 - 5,00 - 6,00 - 8,00 - 10,00	14,63	5

APLICACIONES
APPLICATIONS



Maderas duras
Bois dur / Hardwoods



Contrachapado
Contreplaqués
Plywood



Aglomerado
Stratifié
Plywood



Maderas blandas
Bois tendre
Softwoods

Características
Caractéristiques
Features



3 puntas
madera
3 dents bois
3-tip wood



Rotación
Rotation
Rotation

HSS

Acero rápido
Acier rapide
High speed steel



**APLICACIONES
APPLICATIONS**



Maderas blandas
Bois tendre / Softwoods



Aglomerado
Stratifié
Plywood

**Características
Caractéristiques
Features**



Punta pala PRO
Pointe plate PRO
PRO spade tip



Rotación
Rotation
Rotation



Mango hexagonal 1/4"
Queue hexagonale 1/4"
Hexagonal shank 1/4"



Cambio rápido
Change rapide
Quick change

1303

**Pala Standard
Plat Standard / Standard Spade**



Ref. 1303

Ø mm	L mm	€	
6,00	152	1,47	1
8,00	152	1,71	1
10,00	152	1,81	1
12,00	152	1,88	1
14,00	152	2,04	1
15,00	152	2,35	1
16,00	152	2,35	1
18,00	152	2,51	1
19,00	152	2,67	1
20,00	152	2,67	1
22,00	152	3,30	1
24,00	152	3,60	1
25,00	152	3,76	1
26,00	152	4,07	1
28,00	152	4,38	1
30,00	152	4,69	1
32,00	152	4,93	1
33,00	152	5,15	1
34,00	152	5,70	1
35,00	152	5,95	1
36,00	152	6,20	1
38,00	152	6,43	1
40,00	152	6,73	1

1304

Pala Pro
Plat Pro / Pro Spade



Ref. 1304

Ø mm	L mm	€	
6,00	152	2,26	1
8,00	152	2,40	1
10,00	152	2,65	1
12,00	152	2,81	1
14,00	152	2,90	1
16,00	152	3,34	1
18,00	152	3,50	1
19,00 *	152	3,58	1
20,00	152	3,71	1
22,00	152	4,41	1
24,00	152	4,57	1
25,00	152	4,92	1
26,00	152	5,13	1
28,00	152	5,38	1
30,00	152	5,85	1
32,00	152	6,16	1
33,00 *	152	6,88	1
34,00	152	6,88	1
35,00	152	7,26	1
36,00	152	7,55	1
38,00	152	7,88	1
40,00	152	8,40	1

(Hasta fin de existencias / Jusqu'à épuisement des stocks / While supplies last)

APLICACIONES
APPLICATIONS



Maderas duras
Bois dur / Hardwoods



Contrachapado
Contreplaqués
Plywood



Aglomerado
Stratifié
Plywood



Maderas blandas
Bois tendre
Softwoods

Características
Caractéristiques
Features



Punta pala ST
Pointe plate ST
ST spade tip



Rotación
Rotation
Rotation



Mango hexagonal 1/4"
Queue hexagonale 1/4"
Hexagonal shank 1/4"



Cambio rápido
Change rapide
Quick change

BROCAS PARA MADERA
FORETS À BOIS / WOOD DRILL-BITS



APLICACIONES
APPLICATIONS



Maderas duras
Bois dur / Hardwoods



Contrachapado
Contreplaqués
Plywood



Maderas blandas
Bois tendre
Softwoods

Características
Caractéristiques
Features



Rotación
Rotation
Rotation

1305

Pala Extensible
Plat Extensible / Expansion Spade

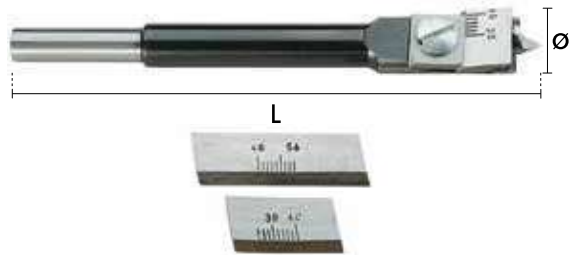

Ref. 1305

Ø mm	L mm	€	
15,00 - 45,00	120	32,26	1
25,00 - 75,00	155	40,30	1

1320

Alargador
Adaptateur / Extension Piece



Ref. 1320

Ø mm	L mm	€	
12,00	300	13,98	1

1306 Lewis

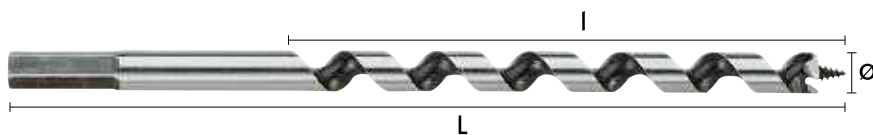

Ref. 1306

Ø mm	L mm	l mm	€	
6,00	235	160	9,88	1
8,00	235	160	9,88	1
10,00	235	160	10,25	1
12,00	235	160	11,66	1
14,00	235	160	12,32	1
16,00	235	160	13,79	1
18,00	235	160	15,79	1
20,00	235	160	17,04	1
22,00	235	160	18,60	1
24,00	235	160	21,13	1
26,00	235	160	23,85	1
28,00	235	160	27,48	1
30,00	235	160	31,61	1
32,00	235	160	35,74	1
8,00	450	350	22,25	1
10,00	450	350	22,25	1
12,00	450	350	23,62	1
14,00	450	350	25,99	1
16,00	450	350	29,78	1
18,00	450	350	32,09	1
20,00	450	350	34,68	1
22,00	450	350	37,69	1
24,00	450	350	41,23	1
26,00	450	350	49,06	1
28,00	450	350	56,29	1
30,00	450	350	67,25	1
32,00	450	350	82,51	1

APLICACIONES
APPLICATIONS



Maderas duras
Bois dur / Hardwoods



Contrachapado
Contreplaqués
Plywood



Maderas blandas
Bois tendre
Softwoods

Características
Caractéristiques
Features



Punta tipo Lewis
Pointe type Lewis
Lewis-type tip



Rotación
Rotation
Rotation



**APLICACIONES
APPLICATIONS**



Maderas duras
Bois dur / Hardwoods



Contrachapado
Contreplaqués
Plywood

**Características
Caractéristiques
Features**



Punta tipo Lewis
Pointe type Lewis
Lewis-type tip



Mango SDS+
Queue SDS+
SDS+ shank



Rotación
Rotation
Rotation

1321 Lewis (SDS+)

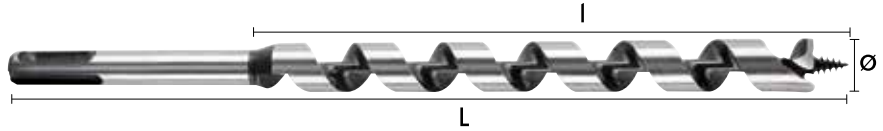

Ref. 1321

Ø mm	L mm	l mm	€	
6,00	200	100	19,30	1
8,00	200	100	19,30	1
10,00	235	160	19,55	1
12,00	235	160	21,36	1
14,00	235	160	24,09	1
16,00	235	160	27,16	1
18,00	235	160	30,42	1
20,00	235	160	32,09	1
22,00	235	160	36,52	1
24,00	235	160	38,88	1
10,00	400	320	26,26	1
12,00	400	320	27,63	1
14,00	400	320	30,42	1
16,00	400	320	33,75	1
18,00	400	320	36,81	1
20,00	400	320	39,59	1
22,00	400	320	43,33	1
24,00	400	320	46,93	1

1307

Encofrar
Coffrage / Shuttering



Ref. 1307

Ø mm	L mm	l mm	€	
6,00	400	370	10,62	1
8,00	400	370	10,76	1
10,00	400	370	12,82	1
12,00	400	370	16,60	1
14,00	400	370	18,39	1
16,00	400	370	21,39	1
18,00	400	370	26,14	1
20,00	400	370	35,29	1
22,00	400	370	47,13	1
24,00	400	370	55,16	1
26,00	400	370	60,73	1
28,00	400	370	66,19	1
30,00	400	370	69,84	1
8,00	600	570	11,44	1
10,00	600	570	13,33	1
12,00	600	570	17,43	1
14,00	600	570	19,06	1
16,00	600	570	22,06	1
18,00	600	570	26,81	1
20,00	600	570	35,82	1
22,00	600	570	47,82	1
24,00	600	570	55,94	1
26,00	600	570	61,53	1
28,00	600	570	67,01	1
30,00	600	570	70,65	1
8,00	800	770	15,51	1
10,00	800	770	17,27	1
12,00	800	770	21,07	1
14,00	800	770	24,14	1
16,00	800	770	28,21	1
18,00	800	770	33,59	1
20,00	800	770	42,52	1
22,00	800	770	55,45	1
24,00	800	770	63,56	1
26,00	800	770	69,07	1
28,00	800	770	74,48	1
30,00	800	770	78,12	1
8,00	1000	970	16,19	1
10,00	1000	970	18,22	1
12,00	1000	970	22,00	1
14,00	1000	970	25,09	1
16,00	1000	970	35,75	1
18,00	1000	970	35,75	1
20,00	1000	970	44,65	1
22,00	1000	970	57,73	1
24,00	1000	970	65,97	1
26,00	1000	970	71,22	1
28,00	1000	970	74,56	1
30,00	1000	970	80,42	1

APLICACIONES
APPLICATIONS



Encofrados
Coffrages / Shuttering

Características
Caractéristiques
Features



Rotación
Rotation
Rotation

**BROCAS PARA MADERA
FORETS À BOIS / WOOD DRILL-BITS**



**APLICACIONES
APPLICATIONS**



**Encofrados
Coffrages / Shuttering**

**Características
Caractéristiques
Features**



**Mango
SDS+
Queue SDS+
SDS+ shank**



**Rotación
Rotation
Rotation**

1318

**Encofrar (SDS+)
Coffrage / Shuttering**

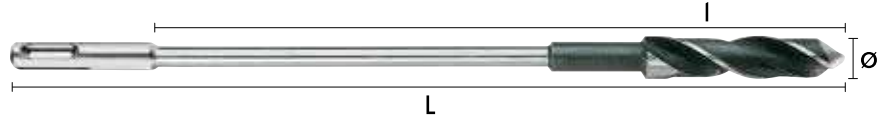

Ref. 1318

Ø mm	L mm	l mm	€	
10,00	400	370	27,97	1
12,00	400	370	31,48	1
14,00	400	370	39,02	1
16,00	400	370	48,91	1
18,00	400	370	64,95	1
20,00	400	370	72,89	1
22,00	400	370	86,27	1
24,00	400	370	91,84	1
26,00	400	370	103,34	1
28,00	400	370	111,99	1
30,00	400	370	126,64	1
32,00	400	370	132,25	1
35,00	400	370	143,81	1
10,00	600	570	29,26	1
12,00	600	570	30,13	1
14,00	600	570	41,93	1
16,00	600	570	51,78	1
18,00	600	570	67,81	1
20,00	600	570	75,76	1
22,00	600	570	83,16	1
24,00	600	570	97,56	1
26,00	600	570	109,14	1
28,00	600	570	117,77	1
30,00	600	570	132,25	1
32,00	600	570	138,03	1
35,00	600	570	149,60	1

1308 **Avellanador**
Fraise à trou et à chanfreiner / Countersink bit



Ref. 1308

Ø mm	d mm	L mm	€	
12,00	3	20	7,20	1
12,00	4	20	7,20	1
12,00	5	20	7,20	1
12,00	6	20	7,20	1
16,00	3	21	9,67	1
16,00	4	21	9,67	1
16,00	5	21	9,67	1
16,00	6	25	9,67	1
16,00	8	25	9,67	1

1314 **Broca Forstner**
Mèche Forstner / Cup drill-bit Forstner



Ø mm	l mm	€		Ø mm	l mm	€	
8	90	10,65	1	36	90	32,81	1
10	90	10,94	1	38	90	35,73	1
12	90	11,67	1	40	90	38,65	1
14	90	12,40	1	42	90	42,29	1
15	90	13,13	1	45	90	44,48	1
16	90	13,56	1	48	90	46,67	1
18	90	13,71	1	50	90	48,85	1
20	90	14,29	1	52	90	62,71	1
22	90	15,02	1	54	90	64,17	1
24	90	17,21	1	58	90	80,21	1
25	90	18,23	1	60	160	84,58	1
26	90	18,96	1	64	160	90,42	1
28	90	20,42	1	68	160	102,08	1
30	90	23,33	1	70	160	116,67	1
32	90	26,25	1	72	160	109,38	1
34	90	28,44	1	76	160	116,67	1
35	90	29,17	1	80	160	122,50	1

APLICACIONES
APPLICATIONS



Maderas duras
Bois dur / Hardwoods



Contrachapado
Contreplaqués
Plywood



Maderas blandas
Bois tendre
Softwoods

Características
Caractéristiques
Features



Ángulo 90°
Angle 90°
Angle 90°



Rotación
Rotation
Rotation

APLICACIONES
APPLICATIONS



Maderas duras
Bois dur / Hardwoods



Contrachapado
Contreplaqués
Plywood



Maderas blandas
Bois tendre
Softwoods

Características
Caractéristiques
Features



Rotación
Rotation
Rotation

**BROCAS PARA MADERA
FORETS À BOIS / WOOD DRILL-BITS**



**APLICACIONES
APPLICATIONS**



Maderas duras
Bois dur / Hardwoods



Contrachapado
Contreplaqués
Plywood



Maderas blandas
Bois tendre
Softwoods

**Características
Caractéristiques
Features**



Rotación
Rotation
Rotation



**APLICACIONES
APPLICATIONS**



Maderas duras
Bois dur / Hardwoods



Contrachapado
Contreplaqués
Plywood



Maderas blandas
Bois tendre
Softwoods

**Características
Caractéristiques
Features**



1309 Cazoleta T1
Mèche type Forstner T1 / Cup drill-bit T1

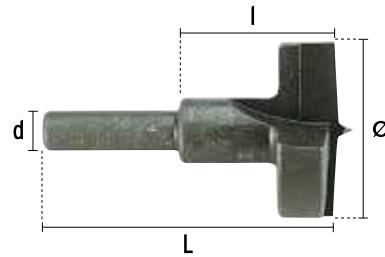

Ref. 1309

Ø mm	d mm	L mm	l mm	€	
26,00	8	57	25	24,36	1
30,00	8	57	25	24,36	1
35,00	8	57	25	24,36	1

1310 Cazoleta T2
Mèche type Forstner T2 / Cup drill-bit T2

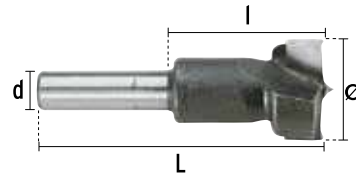

Ref. 1310

Ø mm	d mm	L mm	l mm	€	
20,00	8	57	25	39,22	1
26,00	8	57	25	39,22	1
30,00	8	57	25	39,22	1
35,00	8	57	25	39,22	1

(Hasta fin de existencias / Jusqu'à épuisement des stocks / While supplies last)

1311 Cazoleta T3
Mèche type Forstner T3 / Cup drill-bit T3



Ref. 1311

Ø mm	d mm	L mm	l mm	€	
20,00	10	90	30	71,52	1
26,00	10	90	30	89,20	1
30,00	10	90	30	83,39	1
35,00	10	90	30	92,02	1
40,00	10	90	30	109,84	1

(Hasta fin de existencias / Jusqu'à épuisement des stocks / While supplies last)

7149 Multi



Ref. 7149

Ø mm	Z	€	Icon
25,00	3	62,58	1
30,00	3	63,95	1
35,00	3	65,94	1
40,00	3	68,79	1
45,00	3	79,86	1
50,00	3	86,07	1
55,00	3	86,07	1
58,00	5	89,43	1
60,00	5	89,43	1
63,00	5	89,43	1
65,00	5	89,88	1
68,00	5	89,88	1
70,00	5	122,63	1
74,00	5	123,68	1
80,00	5	130,02	1
85,00	5	145,92	1
105,00	6	170,65	1

(Hasta fin de existencias / Jusqu'à épuisement des stocks / While supplies last)

Accesorios / Accessoires / Accessories

> Ref. 7152 Broca de centrar Ø 7,2 - 8 / Foret de centrage Ø 7,2 - 8 / Centre drill-bit Ø 7,2 - 8

L mm	€	Icon
109	5,53	1
120	7,32	1

> Ref. 7151 MANGO SDS+ / Queue SDS+ / SDS+ Shank

L mm	€	Icon
105	42,90	1
220	57,44	1
370	68,27	1

> Ref. 7150 Mango Hexagonal / Queue hexagonale / Hexagonal shank

L mm	€	Icon
78	36,50	1
220	51,21	1
370	62,26	1

APLICACIONES
APPLICATIONS



Maderas duras
Bois dur / Hardwoods



Contrachapado
Contreplaqués
Plywood



Acero <80Kg
Acier <80Kg
Steel <80Kg



Aluminio
Aluminium



Acero Inox
Acier Inox
Stainless steel



Maderas blandas
Bois tendre
Softwoods



Estratificado
Stratifié
Plywood



PVC

Características
Caractéristiques
Features



Mango SDS+
Queue SDS+
SDS+ shank



Punta Dientes MD
Pointe Dents de MD
MD tooth tip



Rotación
Rotation
Rotation



APLICACIONES
APPLICATIONS

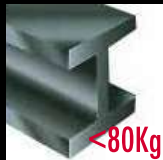

Acero <80Kg
Acier <80Kg / Steel <80Kg



Fundición
Fonte
Cast Iron

Características
Caractéristiques
Features



Serie corta
Série courte
Short series



Punta a 118°
Pointe à 118°
118° Tip



Convencional
Normal
Conventional



Convencional
Normal
Conventional



Espiral a 30°
Spiral à 30°
30° Spiral

8163 Rectificada (HSS DIN 338N)



Ø mm	L mm	l mm	tubo		pack	
			Ref. 8163	Ref. 1101	Ref. 8163	Ref. 1101
1,00	34	12	4,09	3	1,14	10
1,50	40	18	3,60	3	0,96	10
2,00	49	24	3,50	3	0,94	10
2,50	57	30	3,50	3	0,94	10
3,00	61	33	2,36	2	0,83	10
3,25	65	36	2,75	2	1,04	10
3,50	70	39	2,75	2	1,04	10
4,00	75	43	1,74	1	1,07	10
4,25	75	43	2,06	1	1,38	10
4,50	80	47	2,06	1	1,38	10
5,00	86	52	2,04	1	1,36	10
5,25	86	52	2,43	1	1,73	10
5,50	93	57	2,43	1	1,73	10
6,00	93	57	2,50	1	1,82	10
6,50	101	63	3,02	1	2,34	10
7,00	109	69	3,37	1	2,69	10
7,50	109	69	3,73	1	3,03	10
8,00	117	75	3,86	1	3,17	10
8,50	117	75	4,67	1	3,98	10
9,00	125	81	5,01	1	4,36	10
10,00	133	87	5,66	1	4,97	5
11,00	142	94	7,50	1	6,82	5
12,00	151	101	8,68	1	8,01	5
13,00	151	101	10,54	1	9,86	5

Rectificada (HSS DIN 338N)

Estuches / Coffrets / Cases

> Ref. 8123/2*



Ø mm	€	Icon
1,00-1,50-2,00-2,50-3,00-3,50-4,00-4,50-5,00-5,50 6,00-6,50-7,00-7,50-8,00-8,50-9,00-9,50-10,00	45,91	19

(Hasta fin de existencias / Jusqu'à épuisement des stocks / While supplies last)

> Ref. 8124/2



Ø mm	€	Icon
1,00-2,00-3,00-4,00-5,00-6,00-7,00-8,00-9,00-10,00	25,51	10

> Ref. 8125/2



Ø mm	€	Icon
2,00-2,50-3,00-3,50-4,00-4,50-5,00 5,50-6,00-6,50-7,00-7,50-8,00	24,69	13

> Ref. 8126/2



Ø mm	€	Icon
2,00-3,00-4,00-5,00-6,00-8,00	12,48	6



APLICACIONES
APPLICATIONS

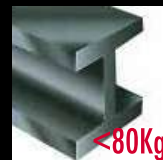

Acero <80Kg
Acier <80Kg / Steel <80Kg



Fundición
Fonte
Cast Iron

Características
Caractéristiques
Features



Serie corta
Série courte
Short series



Punta a 118°
Pointe à 118°
118° Tip



Convencional
Normal
Conventional



Convencional
Normal
Conventional



Espiral a 30°
Spiral à 30°
30° Spiral



**APLICACIONES
APPLICATIONS**



Acero <80Kg
Acier <80Kg / Steel <80Kg



Fundición
Fonte
Cast Iron

**Características
Caractéristiques
Features**



Serie corta
Série courte
Short series



Punta a 118°
Pointe à 118°
118° Tip



Convencional
Normal
Conventional



Convencional
Normal
Conventional



Espiral a 30°
Spiral à 30°
30° Spiral



Cambio rápido
Change rapide
Quick change



Mango hexagonal 1/4"
Queue hexagonale 1/4"
Hexagonal shank 1/4"

1501 HSS Hex.

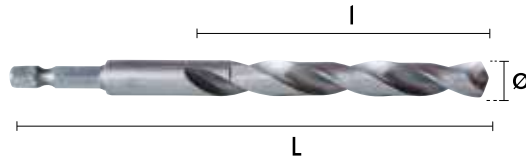

Ref. 1501

Ø mm	L mm	l mm	€	
3,00	61	33	3,72	1
4,00	75	43	4,09	1
5,00	86	52	4,27	1
6,00	93	57	4,60	1
7,00	109	69	4,74	1
8,00	117	75	5,00	1
9,00	125	81	5,07	1
10,00	133	87	6,38	1

1154 Speedplus (HSS DIN 338NSP)



Ø mm	L mm	l mm	tubo		pack	
			Ref. 1154	Ref. 1158	Ref. 1154	Ref. 1158
1,00	34	12	4,38	3	1,25	10
1,50	40	18	3,87	3	1,08	10
2,00	49	24	3,74	3	1,03	10
2,50	57	30	3,74	3	1,03	10
3,00	61	33	2,49	2	0,93	10
3,25	65	36	2,94	2	1,14	10
3,50	70	39	2,94	2	1,14	10
4,00	75	43	1,80	1	1,18	10
4,25	75	43	2,14	1	1,49	10
4,50	80	47	2,14	1	1,49	10
5,00	86	52	2,14	1	1,49	10
5,25	86	52	2,53	1	1,90	10
5,50	93	57	2,53	1	1,90	10
6,00	93	57	2,65	1	2,02	10
6,50	101	63	3,18	1	2,57	10
7,00	109	69	3,59	1	2,97	10
7,50	109	69	4,01	1	3,37	10
8,00	117	75	4,12	1	3,49	10
8,50	117	75	5,06	1	4,41	10
9,00	125	81	5,42	1	4,81	10
10,00	133	87	6,13	1	5,48	5
11,00	142	94	8,17	1	7,54	5
12,00	151	101	9,50	1	8,85	5
13,00	151	101	11,51	1	10,85	5

Estuches / Coffrets / Cases

> Ref. 8124/5



Ø mm	€	pack
1,00-2,00-3,00-4,00-5,00-6,00-7,00-8,00-9,00-10,00	28,85	10

> Ref. 8126/5



Ø mm	€	pack
2,00-3,00-4,00-5,00-6,00-8,00	14,39	6

APLICACIONES
APPLICATIONS

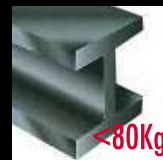

Acero <80Kg
Acier <80Kg / Steel <80Kg



Fundición
Fonte
Cast Iron

Características
Caractéristiques
Features



Serie corta
Série courte
Short series



Punta a 118°
Pointe à 118°
118° Tip



Split Point



Espiral a 30°
Spiral à 30°
30° Spiral



Corrección de labios
Correction de lèvres
Lip correction

**BROCAS PARA METAL
FORETS À MÉTAUX / METAL DRILL-BITS**



**APLICACIONES
APPLICATIONS**

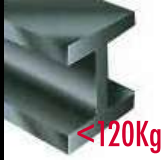

Acero <120Kg
Acier <120Kg / Steel <120Kg



Acero inox
Acier inox
Stainless steel

**Características
Caractéristiques
Features**



Serie corta
Série courte
Short series



Punta a 135°
Pointe à 135°
135° Tip



Split Point



Espiral a 30°
Spiral à 30°
30° Spiral



Corrección de labios
Correction de lèvres
Lip correction

8164 > Cobalt (HSSCO DIN 338N)

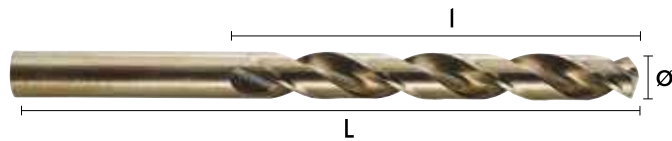

Ø mm	L mm	l mm	tubo		pack	
			Ref. 8164	Ref. 1105	Ref. 8164	Ref. 1105
1,00	34	12	6,18	3	1,86	10
1,50	40	18	5,69	3	1,70	10
2,00	49	24	5,84	3	1,74	10
2,50	57	30	6,18	3	1,86	10
3,00	61	33	3,69	2	1,55	10
3,25	65	36	4,76	2	2,07	10
3,50	70	39	4,70	2	2,05	10
4,00	75	43	2,65	1	2,01	10
4,25	75	43	2,99	1	2,35	10
4,50	80	47	3,10	1	2,46	10
5,00	86	52	2,99	1	2,35	10
5,25	86	52	3,58	1	2,95	10
5,50	93	57	4,37	1	3,72	10
6,00	93	57	3,82	1	3,18	10
6,50	101	63	4,74	1	4,13	10
7,00	109	69	4,96	1	4,36	10
7,50	109	69	5,27	1	4,63	10
8,00	117	75	6,38	1	5,79	10
8,50	117	75	6,33	1	5,68	10
9,00	125	81	7,83	1	7,19	10
10,00	133	87	9,67	1	9,07	5
11,00	142	94	13,95	1	13,31	5
12,00	151	101	17,35	1	16,72	5
13,00	151	101	23,88	1	23,24	5

Estuches / Coffrets / Cases

> Ref. 8124/3



Ø mm	€	pack
1,00-2,00-3,00-4,00-5,00-6,00-7,00-8,00-9,00-10,00	45,20	10

> Ref. 8126/3



Ø mm	€	pack
2,00 - 3,00 - 4,00 - 5,00 - 6,00 - 8,00	21,06	6

8169 Cobalt W (HSS DIN 338W)



Ø mm	L mm	l mm	tubo		pack	
			Ref. 8169	Ref. 1187	Ref. 8169	Ref. 1187
3,00	61	33	6,19	2	2,60	10
3,25	65	36	7,35	2	3,19	10
3,50	70	39	7,20	2	3,14	10
4,00	75	43	4,48	1	3,41	10
4,25	75	43	4,83	1	3,78	10
4,50	80	47	4,77	1	3,78	10
5,00	86	52	5,18	1	4,06	10
5,25	86	52	5,78	1	4,75	10
5,50	93	57	6,03	1	5,14	10
6,00	93	57	6,56	1	5,47	10
6,50	101	63	7,35	1	6,40	10
7,00	109	69	7,95	1	6,97	10
7,50	109	69	8,44	1	7,42	10
8,00	117	75	9,56	1	8,68	10
8,50	117	75	10,11	1	9,06	10
9,00	125	81	12,57	1	11,54	10
10,00	133	87	14,05	1	13,18	5
11,00	142	94	20,55	1	19,62	5
12,00	151	101	25,12	1	24,20	5
13,00	151	101	28,10	1	27,34	5



APLICACIONES
APPLICATIONS



Acero inox
Acier inox / Stainless steel



Aluminio
Aluminium
Aluminium

Características
Caractéristiques
Features



Serie corta
Série courte
Short series



Punta a 135°
Pointe à 135°
135° Tip



Split Point



Corrección de labios
Correction de lèvres
Lip correction



Espiral a 40°
Spiral à 40°
40° Spiral



BROCAS ESCALONADAS
FRAISES ÉTAGÉES / STEP DRILL-BITS



APLICACIONES
APPLICATIONS

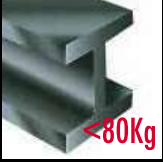

Acero <80Kg
Acier <80Kg / Steel <80Kg



Fundición
Fonte
Cast Iron

Características
Caractéristiques
Features



Punta a 118°
Pointe à 118°
118°Tip



Convencional
Normal
Conventional



2 Cortes
2 Coupes
2 Cuts



Convencional
Normal
Conventional

5105 Broca Escalonada (HSS)



Ø mm	Grad. mm	L mm	d mm	€	
4,00 - 12,00	1	69	6	43,47	1
4,00 - 12,00	2	69	6	45,41	1
4,00 - 20,00	2	75	8	58,66	1
6,00 - 30,00	2	95	10	89,09	1

> Ref. 5140



Ø mm	€	
4-12, 4-20, 6-30	218,07	3

> Ref. 5141



Ø mm	€	
4-20, 6-30	170,50	2

5101 Broca Avellanadora



∅ mm	L mm	d mm	€	
3,00 - 14,00	62	6	21,24	1
6,00 - 20,00	70	6	29,65	1
16,00 - 30,00	78	10	60,34	1
26,00 - 40,00	86	12	127,72	1

> Ref. 5138



∅ mm	€	
3-14, 6-20, 16-30	125,40	3



APLICACIONES
APPLICATIONS

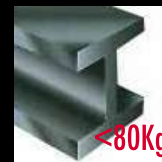

Acero <80Kg
 Acier <80Kg / Steel <80Kg



Fundición
 Fonte
 Cast Iron

Características
 Caractéristiques
 Features



Punta a 118°
 Pointe à 118°
 118°Tip



Convencional
 Normal
 Conventional



2 Cortes
 2 Coupes
 2 Cuts



Convencional
 Normal
 Conventional



**APLICACIONES
APPLICATIONS**

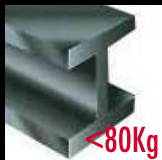

Acero <80Kg
Acier <80Kg / Steel <80Kg



Acero inox
Acier inox
Stainless steel



Aluminio
Aluminium
Aluminium



PVC

**Características
Caractéristiques
Features**



Dentado variable 4/6 tpi
Denture variable 4/6 tpi
Variable touch pitch 4/6 tpi



Ángulo corte neutro 0°
Angle coupe neutre 0°
Neutral cut angle 0°



8% CO



Taladro manual 20 mm
Percapce manuel 20 mm
Manual drill 20 mm

7111 Bimetal M42



Ø mm	P.G.	L mm	Ref. 7111	Ref. 8157	
			€	blister €	
14,00	-	40	14,43	14,96	1
16,00	9	40	14,43	14,96	1
17,00	-	40	14,43	14,96	1
19,00	11	40	14,43	14,96	1
20,00	-	40	14,43	14,96	1
21,00	11	40	14,43	14,96	1
22,00	16	40	14,43	14,96	1
24,00	-	40	14,43	14,96	1
25,00	-	40	15,32	15,87	1
27,00	-	40	16,23	16,77	1
29,00	21	40	16,23	16,77	1
30,00	-	40	16,23	16,77	1
32,00	-	40	16,23	16,77	1
33,00	-	40	16,23	16,77	1
35,00	-	40	17,26	17,80	1
37,00	29	40	17,26	17,80	1
38,00	-	40	17,26	17,80	1
40,00	-	40	17,26	17,80	1
41,00	-	40	17,26	17,80	1
43,00	-	40	17,26	17,80	1
44,00	-	40	21,10	21,65	1
46,00	-	40	21,10	21,65	1
48,00	36	40	21,10	21,65	1
50,00	-	40	21,10	21,65	1
51,00	-	40	21,10	21,65	1
52,00	-	40	24,97	25,51	1
54,00	42	40	24,97	25,51	1
56,00	-	40	24,97	25,51	1
57,00	-	40	24,97	25,51	1
59,00	-	40	24,97	25,51	1

7111 Bimetal M42



Ø mm	P.G.	L mm	Ref. 7111		Ref. 8157	
			€	blister €	€	blister €
60,00	-	40	24,97	25,51	1	
64,00	-	40	27,66	28,21	1	
65,00	-	40	27,66	28,21	1	
67,00	-	40	27,66	28,21	1	
68,00	-	40	27,66	28,21	1	
70,00	-	40	27,66	28,21	1	
73,00	-	40	27,66		1	
76,00	-	40	28,26		1	
79,00	-	40	28,26		1	
83,00	-	40	28,26		1	
86,00	-	40	28,26		1	
89,00	-	40	28,26		1	
92,00	-	40	32,74		1	
95,00	-	40	38,04		1	
98,00	-	40	40,27		1	
102,00	-	40	42,32		1	
105,00	-	40	45,62		1	
108,00	-	40	59,92		1	
111,00	-	40	70,82		1	
114,00	-	40	82,64		1	
121,00	-	40	91,81		1	
127,00	-	40	101,80		1	
133,00	-	40	111,90		1	
140,00	-	40	122,00		1	
152,00	-	40	142,43		1	
160,00	-	40	220,13		1	
168,00	-	40	241,92		1	
177,00	-	40	246,40		1	
210,00	-	40	260,42		1	
250,00	-	40	275,25		1	

APLICACIONES
APPLICATIONS

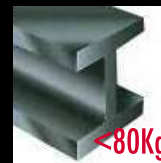

Acero <80Kg
 Acier <80Kg / Steel <80Kg



Acero inox
 Acier inox
 Stainless steel



Aluminio
 Aluminium
 Aluminium



PVC

Características
 Caractéristiques
 Features



Dentado variable 4/6 tpi
 Denture variable 4/6 tpi
 Variable touch pitch 4/6 tpi



Ángulo corte neutro 0°
 Angle coupe neutre 0°
 Neutral cut angle 0°



8% CO



Taladro manual 20 mm
 Percepe manuel 20 mm
 Manual drill 20 mm

7110 **Bimetal Dentado Fino M42**
Denture Fine / Fine Tooth Pitch

APLICACIONES
APPLICATIONS

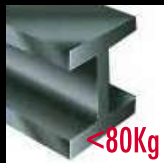

Acero <80Kg
Acier <80Kg / Steel <80Kg



Acero inox
Acier inox
Stainless steel



Aluminio
Aluminium
Aluminium



PVC

Características
Caractéristiques
Features



Dentado fino 10 tpi
Denture fine 10 tpi
Fine touch pitch 10 tpi



Ángulo corte neutro 0°
Angle coupe neutre 0°
Neutral cut angle 0°



8% CO



Taladro manual 20 mm
Percapce manuel 20 mm
Manual drill 20 mm



Ø mm	P.G.	L mm	€	
16,00	9	40	14,43	1
19,00	11	40	14,43	1
20,00	-	40	14,43	1
22,00	16	40	14,43	1
25,00	-	40	15,32	1
27,00	-	40	16,23	1
29,00	21	40	16,23	1
30,00	-	40	16,23	1
32,00	-	40	16,23	1
35,00	-	40	17,26	1
38,00	-	40	17,26	1
40,00	-	40	17,26	1
43,00	-	40	17,26	1
46,00	-	40	21,10	1
48,00	36	40	21,10	1
51,00	-	40	21,10	1
54,00	42	40	24,97	1
57,00	-	40	24,97	1
60,00	-	40	24,97	1
68,00	-	40	27,66	1
70,00	-	40	27,66	1
76,00	-	40	28,26	1
83,00	-	40	28,26	1
98,00	-	40	40,27	1
102,00	-	40	42,32	1

7142

Bimetal Cambio Rápido M42
 Changement Rapide / Quick Change



Ø mm	L mm	€	
19,00	40	17,74	1
20,00	40	17,74	1
22,00	40	17,74	1
25,00	40	18,65	1
29,00	40	19,57	1
32,00	40	19,57	1
35,00	40	20,57	1
38,00	40	20,57	1
41,00	40	20,57	1
44,00	40	20,57	1
48,00	40	24,44	1
51,00	40	24,44	1
54,00	40	28,29	1
57,00	40	28,29	1
60,00	40	28,29	1
64,00	40	30,98	1
68,00	40	30,98	1
70,00	40	30,98	1
76,00	40	31,59	1



APLICACIONES
APPLICATIONS

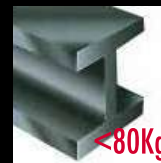

Acero <80Kg
 Acier <80Kg / Steel <80Kg



Acero inox
 Acier inox
 Stainless steel



Aluminio
 Aluminium
 Aluminium



PVC

Características
 Caractéristiques
 Features



Dentado variable 4/6 tpi
 Denture variable 4/6 tpi
 Variable touch pitch 4/6 tpi



Ángulo corte neutro 0°
 Angle coupe neutre 0°
 Neutral cut angle 0°



8% CO



Taladro manual 20 mm
 Percepe manuel 20 mm
 Manual drill 20 mm

7157 **Bimetal TCT**
Métal Dur / Hard Metal

APLICACIONES
APPLICATIONS



Acero inox
Acier inox / Stainless steel



Gres
Grès
Stoneware



Acero <80kg
Acier <80kg
Steel <80kg



Fibra de vidrio
Fibre de verre
Fibreglass

Características
Caractéristiques
Features



Taladro manual 20 mm
Percepe manuel 20 mm
Manual drill 20 mm



Punta dientes MD
Pointe
Dents de MD
MD tooth tip



Ø mm	L mm	€	
19,00	40	52,99	1
22,00	40	52,99	1
25,00	40	56,31	1
29,00	40	61,65	1
32,00	40	61,65	1
35,00	40	61,65	1
38,00	40	61,65	1
44,00	40	79,54	1
48,00	40	79,54	1
51,00	40	79,54	1
54,00	40	93,76	1
57,00	40	93,76	1
60,00	40	93,76	1
64,00	40	101,66	1
70,00	40	101,66	1
76,00	40	103,85	1
83,00	40	103,85	1
86,00	40	103,85	1
89,00	40	103,85	1
95,00	40	139,78	1
102,00	40	155,56	1

Accesorios
 Accessoires / Accessories

► **Ref. 7112 Husillo eje hexagonal** / Arbre axe hexagonal / Hexagonal axis spindle



Rosca Filetage Thread	∅ mm	Hex.	€	
1/2 UNF	14,00-30,00	8,5	15,89	1
1/2 UNF	14,00-30,00	11	15,89	1
5/8 UNF	32,00-250,00	8,5	31,65	1
5/8 UNF	32,00-250,00	11	31,65	1

► **Ref. 7112 Husillo eje SDS+** / Arbre axe SDS+ / SDS+ axis spindle



Rosca Filetage Thread	∅ mm	Hex.	€	
1/2 UNF	14,00-30,00	SDS+	15,89	1
5/8 UNF	32,00-250,00	SDS+	31,65	1

► **Ref. 7113 Broca de Centrar eje L=85** / Foret de centrage axe L=85 / L=85 axis centre drill-bit



∅ mm	Hex.	€	
14,00 - 250,00	∅ 6,35	4,99	1

► **Ref. 7114 Extensión eje L=330** / Extension axe L=330 / L=330 axis extension



∅ mm	Hex.	€	
14,00 - 250,00	11	26,03	1

► **Ref. 7143 Husillo cambio rápido eje hexagonal** / Arbre changement rapide axe hexagonal / Hexagonal axis quick-change spindle



∅ mm	Hex.	€	
14,00 - 210,00	11	48,70	1

► **Ref. 7144 Adaptador** / Adaptateur / Adaptor



∅ mm	Hex.	€	
14,00 - 30,00	-	4,14	1
32,00 - 210,00	-	4,63	1

► **Ref. 7145 Broca de Centrar eje L=100** / Foret de centrage axe L=100 / L=100 axis centre drill-bit



∅ mm	Hex.	€	
14,00 - 210,00	6,25	4,88	1

► **Ref. 7146 Kit cambio rápido husillo+adaptador** / Kit changement rapide arbre+adaptateur / Spindle+adaptor quick-change kit



∅ mm	Hex.	€	
-	-	57,46	1



APLICACIONES
APPLICATIONS



Acero inox
Acier inox / Stainless steel



Acero <120kg
Acier <120kg
Steel <120kg



Aluminio
Aluminium
Aluminium



PVC

Características
Caractéristiques
Features



Punta dientes MD
Pointe
Dents de MD
MD tooth tip



Taladro manual 4 mm
Percepe manuel
4 mm
Manual drill
4 mm



Taladro columna 10 mm
Perceuse à
colonne 10 mm
Drill press
10 mm

7101 **TCT Metal Duro**
Métal Dur / Hard Metal

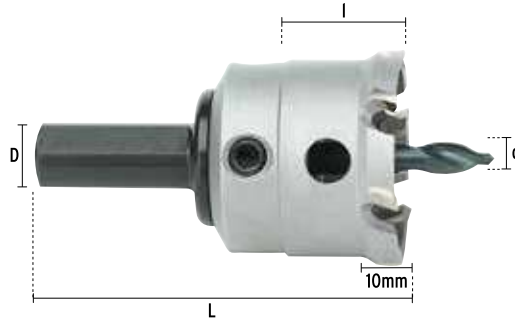

Ø mm	L mm	l mm	z	d mm	D mm	€	
18,00	67,50	22	4	6	10	90,74	1
19,00	67,50	22	4	6	10	88,61	1
20,00	67,50	22	4	6	10	88,61	1
21,00	67,50	22	4	6	10	91,33	1
22,00	67,50	22	4	6	10	91,33	1
23,00	67,50	22	4	6	10	92,73	1
24,00	67,50	22	4	6	10	92,73	1
25,00	67,50	22	4	6	10	92,73	1
26,00	67,50	22	6	6	10	98,17	1
27,00	67,50	22	6	6	10	99,50	1
28,00	67,50	22	6	6	10	99,50	1
29,00	67,50	22	6	6	10	99,50	1
30,00	67,50	22	6	6	10	99,50	1
31,00	67,50	22	6	6	10	117,27	1
32,00	67,50	22	6	6	10	117,27	1
33,00	67,50	22	6	6	10	121,34	1
34,00	67,50	22	6	6	10	122,68	1
35,00	67,50	22	6	6	10	122,68	1
36,00	67,50	22	6	6	10	124,04	1
38,00	67,50	22	6	6	13	124,04	1
39,00	67,50	22	6	6	13	125,42	1
40,00	67,50	22	6	6	13	125,42	1
41,00	67,50	22	6	6	13	148,59	1
42,00	67,50	22	6	6	13	148,59	1
43,00	67,50	22	6	6	13	152,70	1
44,00	67,50	22	6	6	13	152,70	1
45,00	67,50	22	6	6	13	152,70	1
46,00	67,50	22	6	6	13	158,14	1
48,00	67,50	22	6	6	13	158,14	1
49,00	67,50	22	6	6	13	159,48	1
50,00	67,50	22	6	6	13	159,48	1
51,00	67,50	22	6	6	13	184,03	1
52,00	67,50	22	6	6	13	184,03	1
53,00	67,50	22	6	6	13	185,42	1
55,00	67,50	22	6	6	13	185,42	1
56,00	67,50	22	6	6	13	203,13	1
57,00	67,50	22	6	6	13	203,13	1
58,00	67,50	22	6	6	13	203,13	1
59,00	67,50	22	6	6	13	205,87	1
60,00	67,50	22	6	6	13	205,87	1
61,00	67,50	22	8	8	13	231,75	1
62,00	67,50	22	8	8	13	231,75	1
63,00	67,50	22	8	8	13	231,75	1

7101

TCT Metal Duro
Métal Dur / Hard Metal

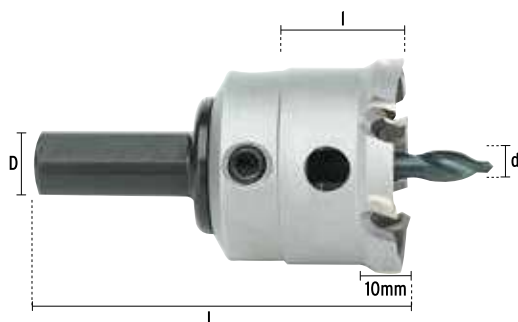

∅ mm	L mm	l mm	Z	d mm	D mm	€	
64,00	67,50	22	8	8	13	231,75	1
65,00	67,50	22	8	8	13	231,75	1
66,00	67,50	22	8	8	13	252,21	1
67,00	67,50	22	8	8	13	252,21	1
68,00	67,50	22	8	8	13	254,94	1
69,00	67,50	22	8	8	13	254,94	1
70,00	67,50	22	8	8	13	254,94	1
75,00	67,50	22	10	8	13	265,84	1
80,00	67,50	22	10	8	13	276,74	1
85,00	67,50	22	10	8	13	279,50	1
90,00	67,50	22	12	8	13	294,47	1
95,00	67,50	22	12	8	13	298,55	1
100,00	67,50	22	12	8	13	306,73	1

APLICACIONES
APPLICATIONS

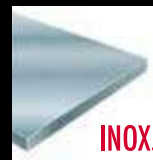

Acero inox
Acier inox / Stainless steel



Acero <120kg
Acier <120kg
Steel <120kg



Aluminio
Aluminium
Aluminium



PVC

Características
Caractéristiques
Features



Punta
dientes MD
Pointe
Dents de MD
MD tooth tip



Taladro
manual 4 mm
Percepe manuel
4 mm
Manual drill
4 mm



Taladro
columna 10 mm
Perceuse à
colonne 10 mm
Drill press
10 mm

Accesorios / Accessoires / Accessories

> Ref. 7102 Broca de Centrar / Centre drill-bit / Foret de centrage



∅ mm	Hex.	L mm	€	
18,00 - 60,00	6	50	4,10	1
61,00 - 100,00	8	50	6,02	1

> Ref. 7103 Cono morse / Cône morse / Morse taper



∅ mm	Hex.	L mm	€	
61,00 - 100,00	-	-	140,29	1

7104

HSS Reafilable
HSS Réaffûtable / Resharpenable HSS

APLICACIONES
APPLICATIONS



Acero inox
Acier inox / Stainless steel



Acero <120kg
Acier <120kg
Steel <120kg



Aluminio
Aluminium
Aluminium



PVC

Características
Caractéristiques
Features



HSS



Taladro manual 5 mm
Perceuse manuel 5 mm
Manual drill 5 mm



Taladro columna 8 mm
Perceuse à colonne 8 mm
Drill press 8 mm



Ø mm	L mm	Z	d mm	D mm	€	
10,00	25	6	5	8	18,73	1
11,00	25	6	5	8	19,72	1
12,00	25	6	5	8	20,80	1
13,00	25	6	5	8	21,84	1
14,00	25	6	6	8	22,46	1
15,00	25	6	6	8	23,16	1
16,00	25	6	6	8	23,73	1
17,00	25	6	6	8	24,10	1
18,00	25	8	6	10	24,43	1
19,00	25	8	6	10	24,62	1
20,00	25	8	6	10	24,93	1
21,00	25	8	6	10	26,18	1
22,00	25	8	6	10	27,42	1
23,00	25	8	6	10	28,67	1
24,00	25	8	6	10	29,91	1
25,00	25	10	6	10	31,16	1
26,00	25	10	6	10	32,43	1
27,00	25	10	6	10	33,68	1
28,00	25	10	6	10	34,92	1
29,00	25	10	6	10	36,15	1
30,00	25	10	6	10	37,39	1
31,00	25	10	6	12	38,64	1
32,00	25	12	6	12	39,90	1
33,00	25	12	6	12	41,16	1
34,00	25	12	6	12	42,41	1
35,00	25	12	6	12	43,64	1
36,00	25	12	6	12	44,89	1
37,00	25	12	6	12	46,12	1
38,00	25	12	6	12	47,40	1
39,00	25	14	6	12	48,65	1
40,00	25	14	6	12	49,88	1
41,00	25	14	6	12	51,12	1
42,00	25	14	6	12	52,36	1
43,00	25	14	6	12	53,66	1
44,00	25	14	6	12	54,89	1
45,00	25	14	6	12	56,13	1
46,00	25	16	6	12	57,39	1
47,00	25	16	6	12	58,63	1
48,00	25	16	6	12	59,86	1
49,00	25	16	6	12	61,13	1
50,00	25	16	6	12	62,37	1
51,00	25	18	8	12	79,50	1
52,00	25	18	8	12	81,05	1
53,00	25	18	8	12	82,64	1
54,00	25	18	8	12	84,16	1
55,00	25	18	8	12	85,74	1

(continúa Ref.7104 / suite Réf.7104 / Ref.7104 cont'd)

7104

HSS Reafilable
HSS Réaffûtable / Resharpenable HSS



∅ mm	L mm	Z	d mm	D mm	€	
56,00	25	18	8	12	87,30	1
57,00	25	18	8	12	88,85	1
58,00	25	22	8	12	90,41	1
59,00	25	22	8	12	92,00	1
60,00	25	22	8	12	93,52	1
61,00	25	22	8	12	107,77	1
62,00	25	22	8	12	109,54	1
63,00	25	22	8	12	111,32	1
64,00	25	22	8	12	113,06	1
65,00	25	22	8	12	114,83	1
66,00	25	22	8	12	116,61	1
67,00	25	22	8	12	118,35	1
68,00	25	24	8	12	120,12	1
69,00	25	24	8	12	121,92	1
70,00	25	24	8	12	123,70	1
75,00	25	24	8	12	132,49	1
80,00	25	24	8	12	141,35	1
85,00	25	26	8	12	163,13	1
90,00	25	26	8	12	171,48	1
95,00	25	28	8	12	181,86	1
100,00	25	28	8	12	192,26	1

APLICACIONES
APPLICATIONS

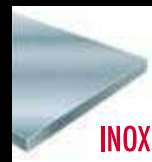

Acero inox
Acier inox / Stainless steel



Acero <120kg
Acier <120kg
Steel <120kg



Aluminio
Aluminium
Aluminium



PVC

Características
Caractéristiques
Features



HSS



Taladro manual 5 mm
Perceuse manuel 5 mm
Manual drill 5 mm



Taladro columna 8 mm
Perceuse à colonne 8 mm
Drill press 8 mm

Accesorios / Accessoires / Accessories

> Ref. 7105 Husillo / Arbore / Spindle



∅ mm	D mm	Hex.	€	
14,00 - 17,00	8	-	9,57	1
18,00 - 30,00	10	-	9,57	1
31,00 - 50,00	12	-	10,21	1
51,00 - 100,00	12	-	12,37	1

> Ref. 7106 Cono Morse / Cône morse / Morse taper



∅ mm	D mm	Hex.	€	
18,00 - 30,00	CM2	-	33,28	1
31,00 - 100,00	CM2	-	33,28	1

> Ref. 7107 Broca de Centrar / Foret de centrage / Centre drill-bit



∅ mm	D mm	Hex.	€	
10,00 - 13,00	-	6	2,90	1
14,00 - 50,00	-	6	3,12	1
51,00 - 100,00	-	8	3,33	1

Bimetal M42



Ref.	Ø mm	Husillos Arbres Spindles	L mm	€	
7163	22,00-25,00-29,00-32,00-38,00	14-30/32-250	-	183,70	1
7164	22,00-29,00-35,00-44,00-51,00-64,00	14-30/32-250	-	222,02	1
7165	19,00-22,00-29,00-38,00-44,00-57,00	14-30/32-250	-	212,63	1
7166	19,00-22,00-25,00-29,00-35,00 38,00-44,00-51,00-57,00	14-30/32-250	-	271,59	1
7115/1	25,00-35,00-43,00-51,00-64,00	14-30/32-210	-	202,24	1
7116/1	19,00-22,00-25,00-29,00-38,00-48,00	14-30/32-210	-	202,07	1
7117	19,00-22,00-25,00-32,00-35,00-38,00 43,00-51,00-57,00-60,00-64,00-76,00	14-30/32-210	330	397,58	1
7148	22,00-25,00-33,00-35,00-41,00-51,00	14-30/32-210	-	234,02	1

Bimetal Dentado Fino M42
Denture Fine / Fine Tooth Pitch

Estuches / Coffrets / Cases



Ref.	Ø mm	Husillos Arbres Spindles	L mm	€	
7115/2	25,00-35,00-43,00-51,00-60,00	14-30/32-210	-	202,24	1
7116/2	19,00-22,00-25,00-29,00-38,00-48,00	14-30/32-210	-	202,31	1

Bimetal Cambio Rápido M42
Changement Rapide / Quick Change

Estuches / Coffrets / Cases



Ref.	Ø mm	Husillo cambio rápido Arbre changement rapide Quick-change spindle	€	
7147	19,00-22,00-25,00-32,00-35,00-38,00 43,00-51,00-57,00-60,00-64,00-76,00	14-210	394,86	1

**HOJAS DE SIERRA DE MANO
LAME DE SCIE À MAIN / HAND HACKSAW BLADE**



**APLICACIONES
APPLICATIONS**



Acero <80Kg
Acier <80Kg / Steel <80Kg

**Características
Caractéristiques
Features**



**APLICACIONES
APPLICATIONS**

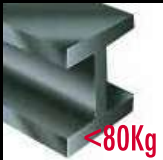

Acero <80Kg
Acier <80Kg / Steel <80Kg

**Características
Caractéristiques
Features**



7501 BIMETAL



L mm	A mm	e mm	z	€	
300	13	0,65	18	2,66	100
300	13	0,65	24	2,66	100
300	13	0,65	32	2,66	100

7504 CV



L mm	A mm	e mm	z	€	
300	13	0,65	24	0,67	100

HOJAS DE SIERRA DE MANO
LAME DE SCIE À MAIN / HAND HACKSAW BLADE

7505 CV



L mm	A mm	e mm	z	€	
300	25	0,65	24	0,80	50



APLICACIONES
APPLICATIONS



Acero <80Kg
 Acier <80Kg / Steel <80Kg

Características
 Caractéristiques
 Features



SIERRAS DE CALAR SCIES SAUTEUSES / JIG SAWS

	Ref.	FOTO	Ref. Bosch	€	uds. envasado	Calidad sierra	Longitud x paso	Tipo dentado	Tipo corte	
MADERA BOIS WOOD	7604		T111C	7,62	5	HCS	75 x 3			
	7603		T144D	8,17	5	HCS	75 x 4-5,2			
	7624		T244D	9,31	5	HCS	75 x 4-5,2			
	7614		T344D	11,55	5	HCS	125 x 4			
	7601		T101B	10,73	5	HCS	75 x 2,7			
	7602		T101D	10,73	5	HCS	75 x 4-5,2			
	7621		T101BR	11,28	5	HCS	75 x 2,5			
	7622		T301CD	13,54	5	HCS	90 x 3			
	7642		T101DP	11,55	5	HCS	75 x 4			
	7643		T234X	17,49	5	HCS	93 x 2-3			
	7644		T308B	18,04	5	HCS	93 x 2,2			
	7623		T101AIF	20,02	5	BIMETAL	75 x 1,6			
	7645		T141HM	21,41	1	HM	75 x 4,3			
	7646		T345XF	25,95	5	BIMETAL	105 x 2,4-5			
	METAL MÉTAUX METAL	7626		T318A	14,66	5	HSS	105 x 1,2		
		7607		T118A	10,73	5	HSS	67 x 1,1-1,5		
7609			T118B	10,73	5	HSS	67 x 1,9-2,3			
7611			T127D	11,28	5	HSS	75 x 3			
7647			T123X	14,66	5	HSS	75 x 1,2-2,6			
7648			T321AF	20,30	5	BIMETAL	105 x 1,2			
7629			T118AF	14,09	5	BIMETAL	67 x 1,1-1,5			
7649			T118BF	14,09	5	BIMETAL	67 x 1,9-2,3			
7650			T118AHM	16,63	1	HM	60 x 1,1			
GRES GRÈS		7651			7,89	1	HM	75 x 1/2		

HOJAS DE SABLE SCIES SABRE / FOR SABRE

	Ref.	FOTO	Ref. Bosch	€	uds. envasado	Calidad sierra	Longitud x paso	Tipo dentado	Tipo corte
MADERA BOIS WOOD	7701		S1344D	29,87	5	HCS	280 x 6		
	7702		S644D	18,04	5	HCS	130 x 6		
	7703		S1531L	32,14	5	HCS	220 x 4-5		
	7704		S611DF	25,37	5	BIMETAL	130 x 6		
	7705		S1111DF	57,49	5	BIMETAL	210 x 6		
	7706		S3456XF	46,23	5	BIMETAL	180 x 11-5		
METAL MÉTAUX METAL	7707		S922BF	21,98	5	BIMETAL	130 x 14		
	7708		S1122BF	27,62	5	BIMETAL	180 x 12,7		
	7709		S522EF	17,49	5	BIMETAL	80 x 18		
	7710		S922EF	21,98	5	BIMETAL	130 x 18		
	7711		S1122VP	27,62	5	BIMETAL	180 x 18		
	7712		S922VF	21,98	5	BIMETAL	130 x 10-14		
	7713		S1122VP	27,62	5	BIMETAL	230 x 10-14		
ESPECIAL DEMOLICIÓN DEMOLITION	7714		S926CHF	42,27	5	BIMETAL	130 x 8-10		
	7715		S1126CHF	50,74	5	BIMETAL	210 x 8-10		
	7719		S1226CHF	62,01	5	BIMETAL	210 x 8-10		
	7717		S922EHM	30,44	1	HM	130 x 18		
	7718		S1243HM	81,74	1	HM	280 x 2		

Madera	Madera tornillos	Aglomerados	Madera verde	Metal	Aluminio	Inox	CU, NI, Ns, Zn Cu, Ni, Ms, Zn	Gres/Cerámica	Ladrillo/Hormigón	Sandwich	Fibro cemento	CFK	Plástico
●		●											●
●		●											●
●			●										
	●												●
	●												●
	●						●						●
				●	●		●						
				●	●		●						
				●									
				●									
				●									
	●			●									
	●			●									
	●			●									
				●		●							
										●		●	

OSCILANTES MULTI-FUNCIÓN
OUTILS MULTIFONCTIONS / OSCILLATING MULTI-TOOLS

APLICACIÓN	REF.	FOTO	ref. Bosch	enganche	€	Uds. envasado	calidad sierra	ancho x alto	dentado
MADERA BOIS WOOD	7720		AIZ 32EPC	STARLOCK	21,25	1	HSC	34x48	1,4
	7721		AIZ 32BSPC	STARLOCK	21,25	1	HSC	32x48	1,8
	7722		AIZ 32BSPB	STARLOCK	28,36	1	Bi-Metal	32x48	1,8
	7723		AII 65BSPC	STARLOCK	26,50	1	HSC	65x40	1,8
	7724		AII65BSPB	STARLOCK	34,13	1	Bi-Metal	65x40	1,8
	7725		PAIZ 32EPC	STARLOCK PLUS	29,52	1	HCS	32x60	1,4
METAL	7726		AIZ 20AB	STARLOCK	20,19	1	Bi-Metal	20x32	1,3
	7727		AIZ 32AB	STARLOCK	23,64	1	Bi-Metal	32x50	1,3
	7728		AIZ 32APB	STARLOCK	29,36	1	Bi-Metal	32x50	1,3
	7729		AII 65APB	STARLOCK	34,13	1	Bi-Metal	65x37	1,3
	7730		ACZ 85EB	STARLOCK	38,32	1	Bi-Metal	ø85	1,4
	7731		PAIZ 32APB	STARLOCK PLUS	38,11	1	Bi-Metal	32x60	1,3
	7732		PAII 65APB	STARLOCK PLUS	45,10	1	Bi-Metal	65x50	1,3
	7733		MAIZ 32APB	STARLOCK MAX	37,84	1	Bi-Metal	32x80	1,3
	7734		MAII 52APB	STARLOCK MAX	41,18	1	Bi-Metal	52x70	1,3
METAL / INOX	7735		AIZ 32AT	STARLOCK	46,69	1	MD	32x37	1,1

OSCILANTES MULTI-FUNCIÓN
OUTILS MULTIFONCTIONS / OSCILLATING MULTI-TOOLS

APLICACIÓN	REF.	FOTO	ref. Bosch	enganche	€	Uds. envasado	calidad sierra	ancho x alto	dentado
ABRASIVO/ ESPECIAL ABRASIF/ SPÉCIAL ABRASIVE/ SPECIAL	7736		AVZ 70 RT4	STARLOCK	86,60	1	MD K40	ø70	
	7737		ACZ 70 RT5	STARLOCK	50,35	1	MD K50	ø70	
	7738		ACZ 85 RT3	STARLOCK	59,31	1	MD K30	ø85	
	7739		ACZ 85 RD4	STARLOCK	96,04	1	DIA-MAN-TE	ø85	
	7740		AVZ 78 RT2	STARLOCK	47,75	1	K20	ø78	
	7741		AIZ 28SC	STARLOCK	31,75	1		28x50	
	7742		ACZ 100SWB	STARLOCK	69,43	1		ø100	
	7743		ATZ52 SC	STARLOCK	24,65	1		52x26	
	7744		AVZ 93G	STARLOCK	19,40	1		ø93	
	7745		MATI68RT3	STARLOCK MAX	76,27	1	K30	68x30	
	7746		MATI68RST5	STARLOCK MAX	76,27	1	K50	68x30	
	7747		MATI68RD4	STARLOCK MAX	126,88	1	K40	68x30	

Fibra Vidrio	CFK	Gres/Cerámica	Abrasivos	Pulido	Aislamiento	Caucho	Restos blandos	Siliconas
●								
●		●	●					
●		●	●					
●		●	●					
●	●	●	●					
			●	●				
			●					●
			●		●	●	●	
			●	●			●	
●		●	●					
●		●	●					
●	●	●	●					

6118 Automático
Automatique / Automatic

- > De uso en taladros portátiles percutores. Perceuses portables à percussion. For use with portable percussive drills.
- > Dispositivo de cierre de seguridad. Dispositif de fermeture de sécurité. Safety lock.



Ø mm	d mm	k	l1 mm	l2 mm	pack		blister	
					Ref. 6118	Ref. 8156	€	€
1,00-10,00	42	3/8" x 24H UNF	65	78	67,00	1	67,59	1
2,00-13,00	42	1/2" x 20H UNF	65	78	77,77	1	78,36	1

6105 Llave Pro
Clé Pro / Pro Key

- > Cierre manual con llave. Serrage manuel avec clé. Manual lock with key
- > De uso en taladros portátiles. Sur perceuses portables. For use with portable drills.
- > Componentes templados y rectificados. Avec des composants trempés et rectifiés. Tempered and rectified components.



Ø mm	d mm	k	l1 mm	l2 mm	gr.	Ref.	pack		blister	
							Ref. 6105	Ref. 8119/1	€	€
1,00-10,00	36,5	1/2" x 20 H	50	60	220	Ref. 6109	42,03	1	42,61	1
1,50-13,00	42,7	1/2" x 20 H	59	74	370	Ref. 6109	53,93	1	54,54	1

6106

Llave
Clé / Key

- > Cierre manual con llave
Serrage manuel avec clé.
Key manual lock.
- > De uso en taladros portátiles
Sur perceuses portables.
For use with portable drills.

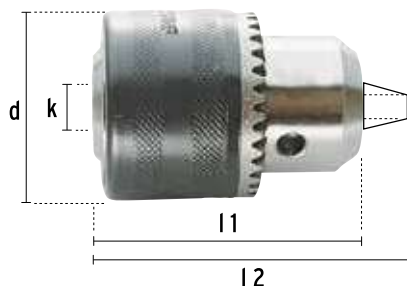

Ø mm	d mm	k	l1 mm	l2 mm	gr.	Ref.	pack		blister	
							€	1	€	1
1,00-10,00	33	1/2" x 20 H	49	59	160	Ref. 6109	23,02	1	23,62	1
1,50-13,00	42,7	1/2" x 20 H	59	74	355	Ref. 6109	25,74	1	26,32	1

6117

SDS+



d1 mm	d2 mm	d3 mm	k	L mm	caja		blister	
					€	1	€	1
21,5	28	29,5	1/2" x UNF	59	88,68	1	89,31	1

(Hasta fin de existencias / Jusqu'à épuisement des stocks / While supplies last)

1224

Adaptador SDS+
Adaptateur SDS+ / SDS MAX adaptor



> SDS MAX

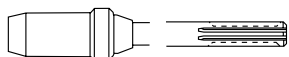

L mm	Ref. 1224	
	€	1
220	115,49	1

6107 > **Adaptador Black & Decker**
Adaptateur Black & Decker / Black & Decker adaptor



	Rosca Filetage Thread	L mm	gr	caja		blister	
				Ref. 6107	Ref. 8120	Ref. 6107	Ref. 8120
	3/8 - 1/2	-	30	€	1	€	1
				5,12	1	5,70	1

6108 > **Adaptador SDS+**
Adaptateur SDS+ / SDS+ adaptor



	Rosca Filetage Thread	L mm	gr	caja		blister	
				Ref. 6108	Ref. 8121	Ref. 6108	Ref. 8121
	1/2 - 20	63	55	€	1	€	1
				31,56	1	32,15	1

6109 > **Llave de recambio**
Clé de Rechange / Spare key



	caja	blister	
		Ref. 6109	Ref. 8122
6109	€	€	€
	4,85	5,43	5,43
	1	1	1

Herpuc EXPOSITORES

Claridad expositiva en el punto de venta para que la elección del producto sea más fácil y cómoda.

PRÉSENTOIRS: Clarté de l'exposition sur le point de vente pour plus de facilité et de commodité dans le choix du produit.

DISPLAY STANDS: Clarity of display at the point of sale so that the selection of the product may be easier and more comfortable.

Herpuc PACKAGING



Nuestra amplia gama de alternativas en la presentación del producto le ayudará a la hora de segmentar a su público, además de especializar la venta a profesionales.

Notre large gamme d'alternatives pour la présentation du produit vous aidera à segmenter votre public ainsi qu'à spécialiser la vente aux professionnels.

Our wide range of alternatives for presenting the product will help when segmenting your clients, in addition to specializing sales to professionals.



TUBO / TUBE



PACK



CLIP



CAJA / BOÎTE / BOX

Herpuc CENTER

- Libre composición
- Productos de alta rotación
- Implantación personalizada

- Libre composition
- Produit de haute rotation
- Implantation personnalisée

- Free composition
- Hight rotation products
- Customized implementation



8207/1 Rectificada (HSS DIN 338 N)

Ø mm	Icon	Ø mm	Icon	Ø mm	Icon
1,00	40	4,50	40	10,00	20
1,50	20	5,00	60	11,00	10
2,00	40	5,50	40	12,00	10
2,25	40	6,00	60	13,00	5
2,50	40	6,50	20	TOTAL	795
3,00	60	7,00	20	€	1.469,27
3,25	40	7,50	20		
3,50	40	8,00	30		
4,00	60	8,50	20		
4,25	40	9,00	20		



8207/2 Speedplus (HSS DIN 338 NSP)

Ø mm	Icon	Ø mm	Icon	Ø mm	Icon
1,00	40	4,25	40	8,50	20
1,50	20	4,50	40	9,00	20
2,00	40	5,00	60	10,00	20
2,25	40	5,50	40	11,00	10
2,50	40	6,00	60	12,00	10
3,00	60	6,50	20	13,00	5
3,25	40	7,00	20	TOTAL	795
3,50	40	7,50	20	€	1.619,36
4,00	60	8,00	30		



8207/3 Cobalt (HSSCO DIN 338 N)

Ø mm	Icon	Ø mm	Icon	Ø mm	Icon
1,00	40	4,50	40	10,00	20
1,50	20	5,00	60	11,00	10
2,00	40	5,50	40	12,00	10
2,25	40	6,00	60	13,00	5
2,50	40	6,50	20	TOTAL	795
3,00	60	7,00	20	€	2.704,59
3,25	40	7,50	20		
3,50	40	8,00	30		
4,00	60	8,50	20		
4,25	40	9,00	20		



8207/4 Cobalt W (HSSCO DIN 338 W)

Ø mm	Icon	Ø mm	Icon	Ø mm	Icon
1,00	40	4,25	40	8,50	20
1,50	20	4,50	40	9,00	20
2,00	40	5,00	60	10,00	20
2,25	40	5,50	40	11,00	10
2,50	40	6,00	60	12,00	10
3,00	60	6,50	20	13,00	5
3,25	40	7,00	20	TOTAL	795
3,50	40	7,50	20	€	4.153,98
4,00	60	8,00	30		



8207/5 Titanium (HSSTIN DIN 338 N)

Ø mm	Icon	Ø mm	Icon	Ø mm	Icon
1,00	40	4,25	40	8,50	20
1,50	20	4,50	40	9,00	20
2,00	40	5,00	60	10,00	20
2,25	40	5,50	40	11,00	10
2,50	40	6,00	60	12,00	10
3,00	60	6,50	20	13,00	5
3,25	40	7,00	20	TOTAL	795
3,50	40	7,50	20	€	3.334,23
4,00	60	8,00	30		



> Ref. 8211

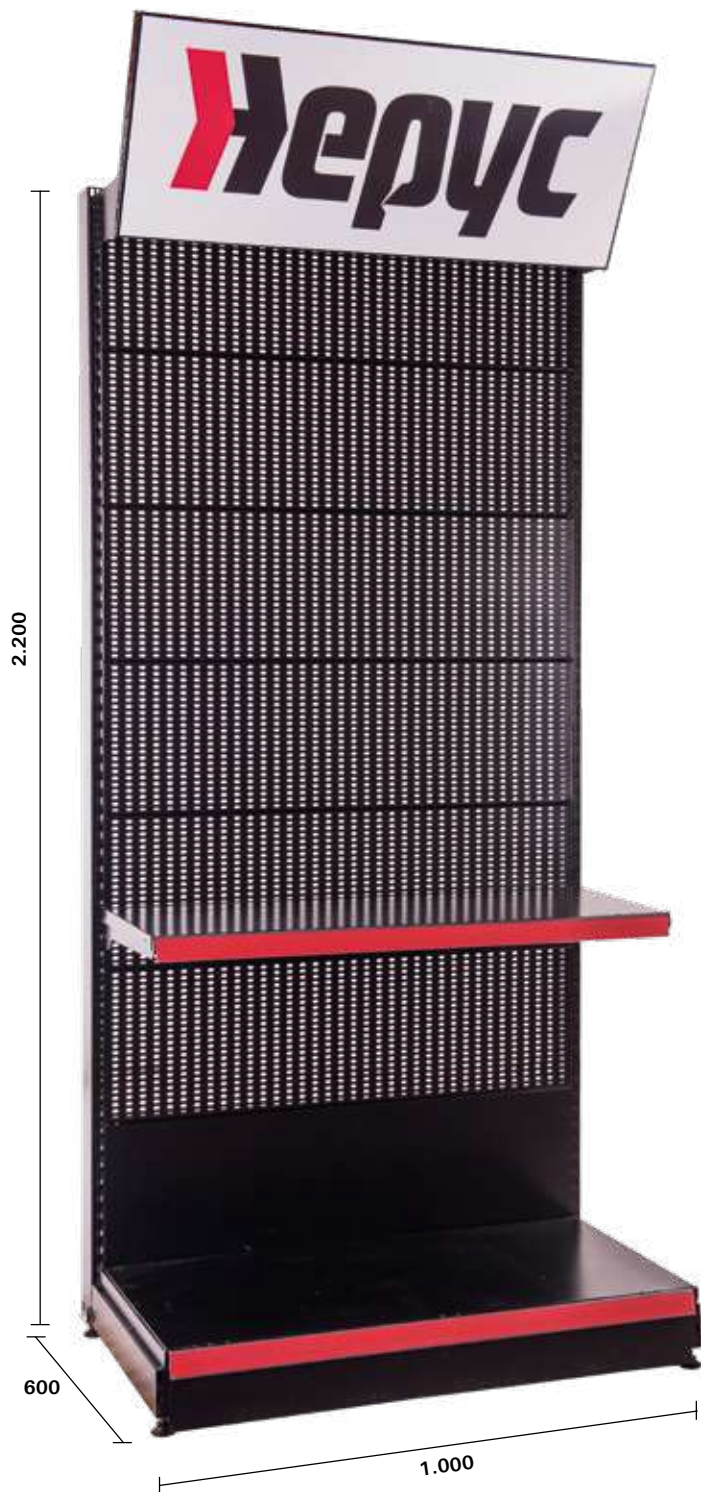

€ 988,77

> Ref. 8212

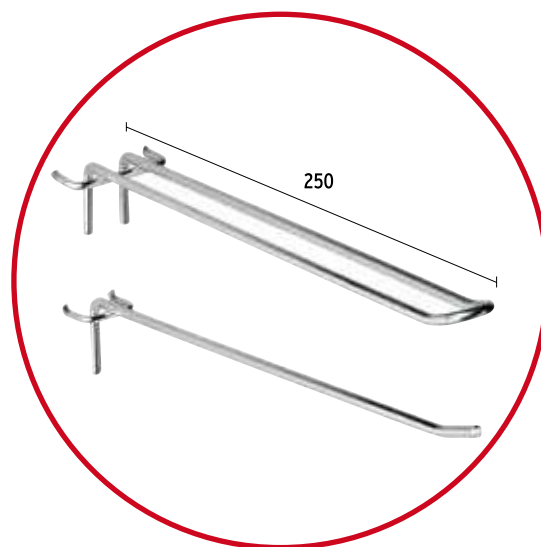

Ref.	€
8212/1	9,06
8212/2	6,77

> Ref. 8207

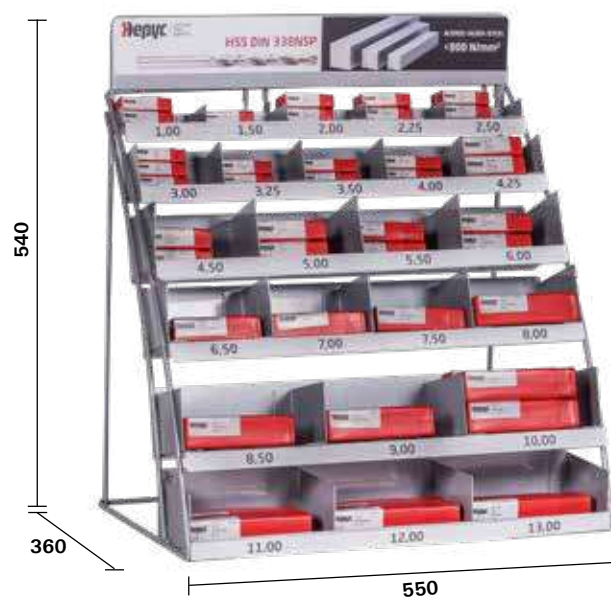

€ 294,60

FICHA NUEVOS CLIENTES

FICHE NOUVEAUX CLIENTS / NEW CLIENT DATA SHEET

FICHA DE CLIENTE

Representante:..... Código de cliente (rellenar por Hepyc):.....

CIF:..... Persona de contacto (nombre y apellido):.....

Dirección de facturación:..... C.P.

Dirección de envío de mercancías (si es diferente):.....

Tel.:..... Fax:..... E-mail:.....

Forma de pago:..... Días pago:.....

CC:..... Dto a aplicar:.....

FORMULAIRE NOUVEAUX CLIENTS

Agent comercial:..... Nom de la société:.....

Raison sociale:..... SIREN/SIRET:.....

Nº Intracomunautaire (TVA):.....

Personne à contacter:.....

Adresse de facturation:.....

Tél.:..... Fax:..... E-mail:.....

Mode de règlement:.....

IBAN:..... Remise:.....

CLIENT DATA SHEET

Representative:..... Client code (to be filled out by Hepyc):.....

Tax Identification Number:.....

Contact person (name and surname):.....

Invoice address:.....

Merchandise delivery address (if different)..... P.C.:.....

Tel.:..... Fax:..... E-mail:.....

Payment method:..... Payment days:.....

IBAN code:..... Discount to be applied:.....

CONDICIONES DE VENTA (España y Portugal)

1º Condiciones de pago:

Giro a 60 días f.f.: NETO.

2º Vencimientos:

En caso de fechas fijas de pago que rebasen los plazos estipulados giraremos a la fecha fijada pero inmediata anterior, según corresponda, siendo el plazo máximo en cualquier caso, de 60 días, fecha factura o envío.

3º Seguros:

Las mercancías viajarán por exclusiva cuenta y riesgo del comprador, siendo siempre a cargo del mismo la prima del seguro que se realice, en los casos que el cliente desee asegurarla.

4º Reclamaciones:

Se atenderán aquellas reclamaciones que se planteen dentro de los 8 días siguientes a la recepción del material, no aceptando ninguna devolución sin previo conocimiento de Manufacturas Hepyc, S.A.

5º Condicionalidad:

La aceptación de las mercancías, sin el rechazo inmediato por parte del comprador, supone la aprobación de estas condiciones generales de venta y su modificación sólo tendrá validez si consta por escrito la conformidad de Manufacturas Hepyc, S.A.

6º IVA:

Los precios están sujetos al impuesto sobre el valor añadido, siendo a cargo del cliente el recargo correspondiente.

7º Garantías:

Todas las herramientas están garantizadas contra cualquier defecto de fabricación y materiales, sin responsabilizarse Manufacturas Hepyc, S.A. de la utilización inadecuada de las mismas. En cualquier caso, nuestra responsabilidad estará limitada al valor de la herramienta suministrada. Nos reservamos el derecho de modificar, sin previo aviso, las dimensiones, calidades de acero y en general todas las características técnicas de las herramientas. No será sustituida ninguna herramienta sin un informe previo de Control de Calidad.

8º Portes:

Se suministrarán a portes pagados aquellos envíos a Península y Baleares cuyo valor neto en factura supere los 150 euros.

En aquellos casos de facturación mensual, quincenal, etc., Manufacturas Hepyc, S.A. cargará en factura los portes correspondientes a los envíos inferiores a 150 euros aunque la factura global (mensual, quincenal) supere dicha cantidad.

9º Importe mínimo por pedido:

Queda establecido como pedido mínimo la cantidad de 60 euros netos. Los clientes no habituales que cursen pedidos inferiores a 60 euros pagarán al contado o contra reembolso.

10º Envío de facturas:

Salvo indicación expresa por parte del cliente, se despacharán directamente.

11º Reserva de dominio:

Nuestras ventas se consideran siempre bajo la condición de "RESERVA DE DOMINIO", según el artículo 1506 del C.C. hasta que se haya hecho efectivo íntegramente el pago de todo lo adeudado.

12º Jurisdicción competente:

En caso de cualquier litigio por razón de incumplimiento por cualquiera de las partes, se someterán ambas al fuero de los JUZGADOS Y TRIBUNALES DE SAN SEBASTIÁN, con denuncia al que pudiera corresponderles.

CONDITIONS DE VENTE (France)

1° Tarif de prix:

Les prix figurants dans ce tarif sont des prix conseillés et s'entendent HORS TAXES, emballage compris.

2° Remise sur Tarif:

Remise à confirmer par notre agent.

3° Délai d'expédition:

Service normal: Commandes reçues avant 14 heures partiront de Hepyc le jour même et seront chez le client en 24-48 heures.

Service express: Sous 24 heures.

4° Port:

FRANCO pour les expédition dont la valeur nette facturée dépasse les 250 euros.

Les commandes inférieures à 250 euros seront majorés d'un forfait de 15 euros.

Manufacturas Hepyc, SA se réserve le droit d'utiliser le moyen de transport le plus économique.

Manufacturas Hepyc, SA facturera les ports concernant les envois d'outils peu courants qui, à la demande du client, devront être livrés en urgence à travers des agences de transport rapide.

5° Condition de paiement:

Le délai de paiement part de la date de facturation. Par LCR magnétique à 60 jours calendaires ou 45 jours fin de mois.

6° Assurances:

Le marchandises seront transportées aux risques et périls exclusifs de l'acheteur, celui-ci étant responsable de la prime d'assurance le cas échéant.

7° Réclamations:

Les réclamations seront acceptées dans un délai de 8 jours à partir de la réception du matériel; aucun retour ne sera accepté sans l'accord préalable de Manufacturas Hepyc, SA.

8° Conditionnalité:

L'acceptation de marchandises sans le rejet immédiat de la part de l'acheteur suppose l'approbation de ces conditions générales de vente et leur modification n'aura de validité que sur confirmation écrite de Manufacturas Hepyc, SA.

9° Garanties:

Tous les outils sont garantis contre n'importe quel défaut de fabrication et de matériaux, Manufacturas Hepyc, SA. n'étant pas responsable de leur utilisation inadéquate. Dans tous les cas, notre responsabilité sera limitée à la valeur de l'outil fourni. Nous nous réservons le droit de modifier, sans avertissement préalable, les dimensions, les qualités d'acier et en général toutes les caractéristiques techniques des outils. Aucun outil ne sera remplacé sans rapport préalable du contrôle de qualité.

10° Réserve de propriété:

La marchandise reste la pleine et entière propriété de la Société Manufacturas Hepyc, SA tant que le règlement intégral n'aura pas été effectué et ce en application de la loi du 12 mai 1980.

SALES CONDITIONS (Export)

1. Price List:

The prices that appear on this price list are recommended and DO NOT INCLUDE TAXES or packaging.

2. Discount: Discount to be confirmed by Manufacturas Hepyc.

3. Payment conditions:

Terms of payment set from invoice date.

First order must be paid in advanced. Rest of the orders to be agreed.

4. Insurance:

The merchandise will be transported exclusively at the purchaser's risk, the purchaser is responsible for the insurance premium if it is necessary.

5. Claims:

Claims will be accepted within the 8 days following the receipt of the merchandise; no returns will be accepted without the prior agreement of Manufacturas Hepyc, SA.

6. Conditions :

The acceptance of merchandise without the immediate rejection on the part of the purchaser supposes the acceptance of these general sales conditions and their modification will not be valid without the written consent of Manufacturas Hepyc, SA.

7. Guarantees:

All tools are guaranteed against any material or manufacturing defect, Manufacturas Hepyc, SA. is not responsible for their improper use. In all cases, our responsibility will be limited to the tool provided. We reserve the right to modify, without preliminary warning, the dimensions, steel qualities and all design features of the tools in general. No tool will be replaced without the preliminary quality control report.

8. Reservation of title:

The merchandise remains the sole and exclusive property of the Manufacturas Hepyc, SA Corporation as long as the full payment is outstanding pursuant to the law of 12 May 1980.

Can we **Help** you?

ATENCION AL CLIENTE NACIONAL

Tel. +34 943 33 50 40
Fax +34 943 33 52 24
ventas@hepyc.com

EXPORT CUSTOMER SERVICE

Tel. +34 943 33 60 03
Fax +34 943 33 52 24
export@hepyc.com

S.A.T

Tel: +34 943 33 52 26
Fax: +34 943 33 52 24
sat@hepyc.com

SEDE SOCIAL / HEAD OFFICE

Pol. Ind. Ibarluce 57 - E Izq.
20120 Hernani (Spain)
Tel. +34 943 33 52 25
Fax +34 943 33 52 24
ventas@hepyc.com

HEPYC CATALUÑA

C/Xarol, 12 - B
08915 Badalona (Spain)
Tel. +34 933 87 32 99
Fax +34 933 83 33 08
vendes@hepyc.com

HEPYC MADRID

C/ Conde Vistahermosa, 46
28019 Madrid (Spain)
Tel. +34 915 69 81 05
Fax +34 915 65 97 91
madrid@hepyc.com